

|24



RUDY PROJECT 2024 COLLECTION

2023
WPL
BETA EDITION
THIS IS A
CONFIDENTIAL
PREVIEW.
CHANGES MAY OCCUR
BEFORE FINAL RELEASE.

EYEWEAR
SPORT PRESCRIPTION
HELMETS

|24



RIDETOZERO IS A TRULY NEW PHILOSOPHY THAT DIRECTS EVERY RUDY PROJECT ACTION. WE ARE A COMPANY WITH SPORT IN OUR DNA AND WE ARE AWARE THAT CLIMATE CHANGE CREATES NEW CHALLENGES THAT MUST BE FACED. OUR ULTIMATE GOAL IS TO SAVE OUR ENDANGERED ENVIRONMENT, THE VITAL ELEMENT TO LIVE AND TO FULFILL OUR INNATE PASSION FOR SPORTS. FOR THIS REASON, WE HAVE EMBRACED THE RIDETOZERO PHILOSOPHY AND WE ARE COMMITTED TO MINIMIZE THE ENVIRONMENTAL IMPACT OF RUDY PROJECT PRODUCTS, DESIGN AND ORGANIZATIONAL PROCESSES.

keep training elevate your performance ■

SPORT CAN MAKE A SIGNIFICANT CONTRIBUTION TO YOUR QUALITY OF LIFE, AND NUMEROUS ACADEMIC STUDIES SHOW IT CAN IMPACT PHYSICAL AND MENTAL HEALTH, SOCIAL LIFE AND LIFE OPPORTUNITIES.



collection

what's new ■

- 12 RIDE TO ZERO
- 16 Eyewear Lens Family
- 18 ImpactX® technology
- 20 ImpactX® collection lenses
- 22 Polar 3FX HDR
- 24 RP OPTICS technology
- 26 RP OPTICS collection lenses
- 28 Technology Features

performance ■

- 32 Agent Q
- 34 **Kelion**
- 36 Cutline
- 38 Defender
- 40 Tralyx+
- 42 Tralyx+ Slim
- 44 Magnus
- 48 Stardash
- 50 Rydon
- 52 Rydon Slim
- 54 Spinshield
- 55 Spinshield Air
- 56 **Astral**
- 58 **Sirius**
- 60 Deltabeat
- 62 Propulse
- 64 GUARD COLLECTION
- 64 Agent Q Guard
- 64 Tralyx Guard
- 64 Intron Guard

active lifestyle ■

- 68 Lightflow A
- 69 Lightflow B
- 70 **Stellar**
- 71 Overlap
- 73 Spinair 57
- 74 Spinhawk
- 75 Soundrise
- 76 Skytrail
- 77 Croze

rx optical ■

- 80 RX Solutions
- 81 Quick Optical Guide
- 82 ImpactRX Lens Collection
- 84 RP Optics
- 85 Polar 3FX 1.59
- 86 Lens marking
- 88 RX collection
- 90 OPTICAL INSERTS
- 92 OPTICAL DOCK
- 94 RX DIRECT CLIPS
- 96 Inkas / Inkas XL
- 98 Maya
- 100 RX READERS
- 102 RX FLIP UP
- 104 Inkas / Inkas XL Flip-Up
- 106 RX OPHTHALMIC
- 108 **Lightflow A**
- 109 **Lightflow B**
- 110 PULSE 53
- 111 PULSE 54
- 112 Iridis 65
- 113 Iridis 66

bike helmets ■

- 116 Helmets technology
- 118 Aero helmets technology
- 120 Wind Tunnel Testing Session
- 122 Total safety technology
- 123 RP Rotational Impact Test
- 124 The Wing
- 126 Nytron
- 127 **Nytron PRO**
- 128 Egos
- 132 Spectrum
- 134 Protera +
- 136 Venger Cross
- 138 Venger
- 140 Crossway
- 142 Skudo
- 144 Central +
- 146 Strym Z
- 148 Helmet Protector
- 149 Helmets Sizing/Fitting
- 150 Color Match

snow ■

- 154 Spincut
- 155 Skermo

gear & pop ■

- 158 Crew & T-Shirt
- 159 Socks & Gloves
- 160 Cyclingwear
- 162 Bags & Packs

- 164 **RETAIL**
- 166 Displays
- 168 Corner System
- 170 Merchandising
- 172 P.O.P.

style finder ■

items in **BOLD** are new entries for 2024



road ■

TEAM BAHRAIN VICTORIOUS
© SPRINTCYCLINGAGENCY



mtb ■

M. MONTAGNI
© CARLO DE SANTIS



x-country ■

JOHANNES HØSFLOT KLÆBO
© NORDIC FOCUS



extreme ■

SZILVIA LUBICS



triathlon ■

BEN KANUTE
© JOHN SEGESTA



gravel ■



winter ■

© G.DANIELI



trail running ■

R.MASTROTTO
© RACEPHOTOS

Elevate your performance ■



running ■

© STEPHAN ADOLPH



outdoor ■



kelion ■

Unleash your potential with Rudy Project Kelion sunglasses! Eco-friendly, stylish, & tailored for athletes, especially bikers. Experience crystal-clear vision, custom fit, fog-free lenses, & unstoppable performance. Elevate your game with Kelion today!



astral ■

Affordable, comfy, sustainable & ultra-lightweight at 25g! Astral sunglasses offer cutting-edge tech, adjustable fit, eco-friendly frames & trendy lenses. Experience unmatched eyewear performance & style!



sirius ■

Affordable, innovative eyewear, ideal for prescription wearers. Customizable features, sustainable materials, and exceptional comfort meet wallet-friendly pricing. Boost your look with Sirius now!



stellar ■

The ultimate blend of sport tech & style for your active life. Perfect for city strolls, beach volleyball, commuting & more. Lightweight, durable, with polarized lenses & UV protection. Your active style statement gets a boost.



nytron pro ■

Get ready to redefine your cycling experience with our new Nytron Pro! Born from intensive wind tunnel testing, this helmet enhances aerodynamic performance by an impressive 2 Watts compared to its predecessor, the Nytron. Tailored for road cyclists, it offers the perfect balance between high-speed efficiency and ventilation, with only a minor 11% reduction in the latter. Discover the perfect blend of comfort and performance with the Nytron Pro - where advanced technology meets real-world cycling needs.

what's new ■

responsible sport eyewear

R&D FOR REDUCED ENVIRONMENTAL FOOTPRINTS

Drawing from Rudy Project's years of experience in research and development for product improvement, we are now focusing on using that knowledge to lower the emissions of our products, making a strong effort towards better environmental sustainability.



RILSAN CLEAR is available only on Kelion, Sirius, Astral, Stellar, Magnus, Deltabeat, Overlap, Lightflow, Pulse, Stardash.



RESPONSIBLE FRAME MATERIALS

In our pursuit of "Frame Materials" innovation, we are expanding the use of Rilsan Clear, a bio-plastic derived from 45% castor oil grown by certified farmers in Gujarat, India, who adopt improved farm waste management practices. This environmentally conscious material enables us to reduce our reliance on fossil-based materials for eyewear frames, aligning with our commitment to sustainable and responsible manufacturing. Rilsan Clear is available on a selection of Rudy Project frames; please consult the product information sheets for further details.



MAXIMUM DURABILITY

Rudy Project's exceptional durability sets them apart as a sustainable choice; their long-lasting performance ensures a sound investment in the future, reducing the need to purchase additional eyewear and conserving energy in production. Designed to withstand the most extreme weather conditions, these glasses truly embody the ultimate in lasting quality and eco-conscious design.



TIMELESS DESIGN

Rudy Project's "timeless design" encapsulates an enduring appeal, as their eyewear effortlessly melds Italian style with sporty functionality, resulting in a fashionable yet elegant aesthetic. This evergreen approach ensures that Rudy Project glasses remain perpetually in vogue, transcending fleeting trends while retaining their sophisticated charm.



VERSATILITY

Rudy Project's "versatility" lies in the elegant design of their eyewear, making them ideal for a wide range of sports disciplines, as well as for commuting or strolling through the city. This adaptability ensures both style and functionality, offering a seamless blend of performance and sophistication suitable for diverse activities and environments.



LOW-IMPACT PACKAGING SOLUTIONS

Embracing "Eco Packaging," we have streamlined our approach to minimize waste and unnecessary materials. By eliminating plastic laminations from our paper products, utilizing recycled plastic for our eyewear cases, and eradicating single-use plastic, we are dedicated to fostering a more environmentally responsible packaging solution.



LONG TERM PRODUCT ASSISTANCE

We offer extended support (as a paid service beyond warranty terms) to extend the life of eyewear by replacing scratched lenses or worn-out components. This commitment ensures our customers can maintain and enjoy their Rudy Project glasses for years to come, promoting both sustainability and customer satisfaction.



3 GOOD HEALTH AND WELL-BEING

We promote sports as a key element to ensuring a healthy lifestyle, and promote well-being for everyone of all age

Our products help enhance sports performance because of our relentless pursuit of superior comfort, safety, and aerodynamics

We promote environmental protection because our planet is the playground for outdoor sports

5 GENDER EQUALITY

We design and promote specific gender products

50% of our employees are male and 50% are females

50% of our managers are male and 50% are females

We provide for parentale leave

Flexibility on working time

7 AFFORDABLE AND CLEAN ENERGY

We produce a share of our electric energy with solar panels

We offset our carbon emissions by financing reforestation projects

We are committed to reducing waste by raising awareness among all our stakeholders

8 DECENT WORK AND ECONOMIC GROWTH

We are working to make the workplace more inclusive through more transparent and holistic internal communication

We train our employees to improve their safety and professional skills according to their own talents

We support our local economy by manufacturing 100% of Rudy Project glasses in Italy

We contribute to our employees' social welfare

9 INDUSTRY, INNOVATION AND INFRASTRUCTURE

We invest in environmentally sustainable product innovation to deliver better performance

We are hiring more people who live closer to the company headquarters to reduce travel emissions

12 RESPONSIBLE CONSUMPTION AND PRODUCTION

Rudy Project sunglasses are designed to last through the use of high-quality manufacturing materials

We are incrementally moving toward bio-based plastics in sunglass frame production

Our Research and Design department is working to make products easier to disassemble and recycle at the end of their life cycles

Sunglass packaging is recyclable and partly manufactured from recyclable sources

We are committed to separating waste and recycling materials as much as possible

sustainable development



eyewear lens families

impactx[®]

UNBREAKABLE PHOTOCROMIC OPTICS



ImpactX[®] the most advanced technological solution in the field of vision protection.

p.19 for futher informations

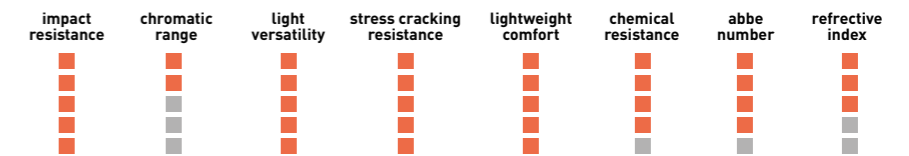

impactrx[®]

SPORTS PRESCRIPTIONS



ImpactRX[®] the most advanced technological solution in the field of vision protection.

p.82 for futher informations

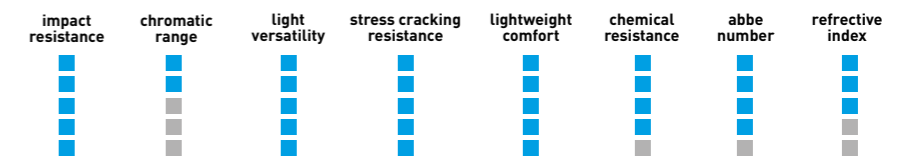

POLAR 3FX HDR



Polar3FX HDR technology eliminates glare providing superior visual comfort, enhanced contrast and contours. In addition, the new Polar3FX lenses incorporate the HDR (high dynamic range) filter to further define contrast and color perception.

p.23 for futher informations

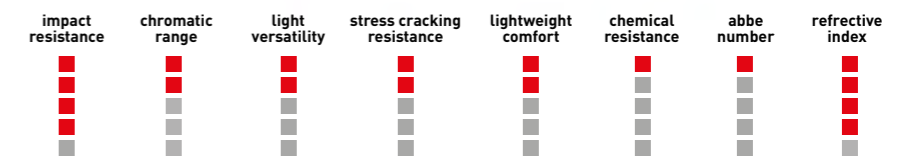

RP OPTICS



RP Optics lenses protect against harmful UV rays up to 400 nm and offer a range of over 30 available colors. Ideal for athletes and weekend warriors who demand performance but accept no compromise when it comes to appearance.

p.25 for futher informations

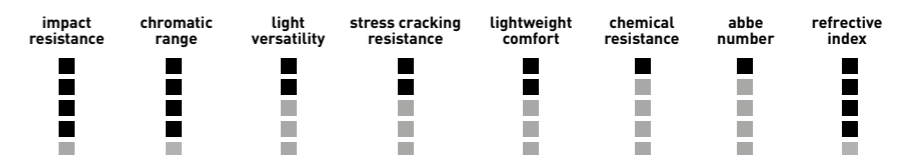

BUILDING ON THE SUCCESS OF IMPACTX® TECHNOLOGY AND FOLLOWING YEARS OF EXTENSIVE LABORATORY RESEARCH AND FIELD TESTS WITH PROFESSIONAL ATHLETES, RUDY PROJECT PROUDLY UNVEILS IMPACTX® 2, A BREAKTHROUGH COLLECTION OF TECHNICAL LENSES. THESE LENSES BOAST EXCEPTIONAL PHOTOCHROMIC PROPERTIES, UTILIZING CUTTING-EDGE PARTICLES FOR UNMATCHED CLIMATIC MANAGEMENT TECHNOLOGY.

IMPACTX® 2 LENSES ADAPT RAPIDLY, TRANSITIONING FROM LOW TO HIGH LIGHT TRANSMISSION IN JUST A FEW SECONDS. THEY CAN ALSO BE TAILORED TO ACHIEVE A CUSTOM COLOR FROM AN INITIALLY CLEAR STATE. THIS REMARKABLE FEATURE ENHANCES CONTRAST, EVEN IN DARKER CONDITIONS, IMPROVING VISUAL ACUITY AND DEPTH PERCEPTION FOR A SUPERIOR VIEWING EXPERIENCE.

IN ADDITION TO THEIR OUTSTANDING VISUAL PERFORMANCE, IMPACTX® 2 LENSES PROVIDE UNPARALLELED EYE PROTECTION. THEY SHIELD THE EYES FROM HARMFUL ELEMENTS, ENSURING SAFETY AND COMFORT DURING VARIOUS OUTDOOR ACTIVITIES. RUDY PROJECT'S COMMITMENT TO INNOVATION AND EXCELLENCE IS EVIDENT IN IMPACTX® 2, OFFERING ATHLETES AND OUTDOOR ENTHUSIASTS THE PERFECT COMBINATION OF ADVANCED TECHNOLOGY, FUNCTIONALITY, AND STYLE.

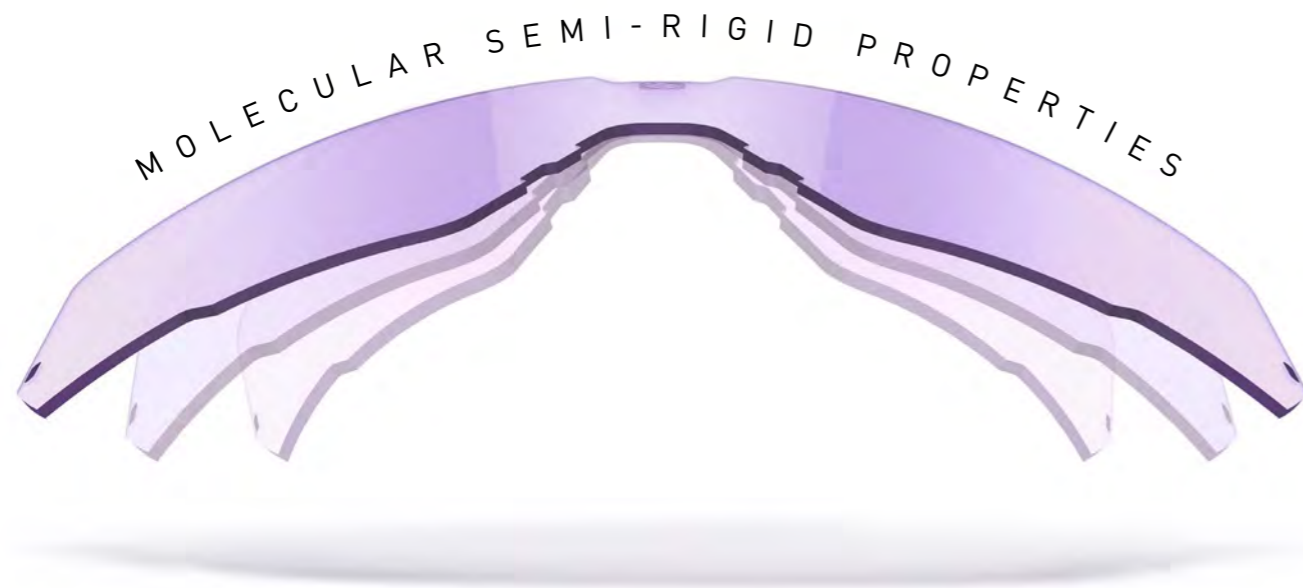

ImpactX technology

impactx[®]

UNBREAKABLE PHOTOCHROMIC OPTIC

GUARANTEED | UNBREAKABLE FOR LIFE

Experience the unbeatable durability of ImpactX® lenses, exclusively designed for Rudy Project. These semi-rigid lenses provide ultimate eye protection against impacts, chemicals, and atmospheric elements while minimizing injury risks. Ideal for sports enthusiasts seeking enhanced safety and performance.



PHOTOCHROMIC | TECHNOLOGY

ImpactX photochromic lenses by Rudy Project offer seamless adaptation to lighting conditions, ensuring perfect visibility and protection. With quick responsiveness, unmatched durability, and complete UV protection, these lenses are ideal for sports enthusiasts and outdoor adventurers.



ULTIMATE | CLARITY

ImpactX® lenses outperform polycarbonate with a lower refraction index, reduced internal stress, and lower chromatic dispersion, providing higher definition and sharper images. The minimized surface reflection and "rainbow effect" deliver a superior visual experience for sports and outdoor enthusiasts.

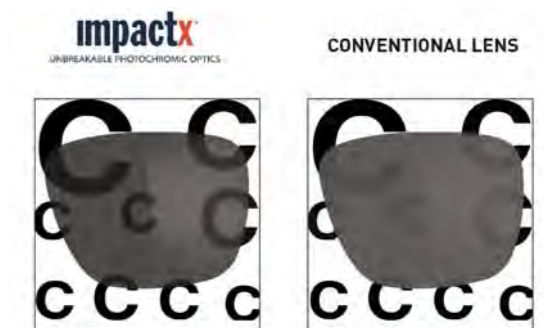

LIGHTWEIGHT

ImpactX® lenses excel in performance, being 16% lighter than CR-39 and 10% lighter than polycarbonate. With lower internal stress and chromatic dispersion, these lenses provide sharper images, higher definition, and reduced "rainbowing" for enhanced visual comfort. Experience state-of-the-art photochromic and polarized technology for exceptional weather management and a superior eye-wear experience.





ImpactX collection lens

impactx[®]

UNBREAKABLE PHOTOCHROMIC OPTIC

impactx 2lasercrimson

IMPACTX[®] PHOTOCROMIC 2 LASER CRIMSON

☞ 25% - 6% | Cat. 2/4
NOT SUITABLE FOR DRIVING

activated
cosmetic appearance



impactx 2black

IMPACTX[®] PHOTOCROMIC 2 BLACK

☞ 74% - 9% | Cat. 1/3

activated
cosmetic appearance



impactx 2laserblack

IMPACTX[®] PHOTOCROMIC 2 BLACK

☞ 62% - 13% | Cat. 1/3

activated
cosmetic appearance



impactx 2red HDR

IMPACTX[®] PHOTOCROMIC 2 RED

☞ 76% - 17% | Cat. 1/3

activated
cosmetic appearance



impactx 2laserred HDR

IMPACTX[®] PHOTOCROMIC 2 LASER RED

☞ 75% - 16% | Cat. 1/3

activated
cosmetic appearance



impactx 2laserbrown HDR

IMPACTX[®] PHOTOCROMIC 2 LASER BROWN

☞ 73% - 17% | Cat. 1/3

activated
cosmetic appearance



impactx 2laserpurple HDR

IMPACTX[®] PHOTOCROMIC 2 LASER PURPLE

☞ 48% - 8% | Cat. 1/3

activated
cosmetic appearance







polar 3fx HDR | technology.

The POLAR 3FX lenses features the HDR filter which is fine tuned to maximize your safety by improving contrast in urban, mountain and road bike environments.

The result is bright and comfortable vision, sharper details perception and brighter colors with considerable reduction in eye fatigue. The POLAR 3FX Multilaser lenses are available in a vast array of colors allowing to benefit from they superior visual comfort and to choose the color which best suits for your style.

Our POLAR 3FX technology protects your eyes from harmful UV rays and eliminates glare by selectively filtering non harmful wavelenghts through the lens. POLAR 3FX technology is designed to filter glare from car headlights, sun rays and the refracted light on wet or shiny surfaces like water and snow.

 **POLAR 3FX HDR MULTILASER BLUE**
 ☞ 18% | Cat.3 ☀ ☁ ☁

 **POLAR 3FX HDR MULTILASER RED**
 ☞ 16% | Cat.3 ☀ ☁ ☁

 **POLAR 3FX GREY***
 ☞ 10,8 % | Cat.3 ☀ ☁ ☁

 **POLAR 3FX HDR MULTILASER GREEN**
 ☞ 16% | Cat.3 ☀ ☁ ☁

WITH ANTI-REFLECTIVE COATING

* not available with HDR technology

HDR TECHNOLOGY

The HDR filter is designed to boost your color experience by tuning the wavelength of the light passing through the lens. By actively refining the intensity of various wavelenghts of light and by optimizing the visible, the HDR filter provides extraordinary visual performance. In addition to a maximized chromatic range, benefits include superior perception, sharper image and unparalleled contrast definition.

3FX COATINGS

This state-of-the-art coating has been developed to make Polar3FX lenses tougher and more durable. The 3FX coating is a hydrophobic barrier which minimizes the formation of smudges. This treatment is designed to enable water slipping on the surface, to prevent stains and fingerprints and to make cleaning easier.

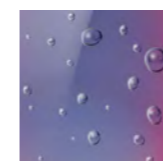

Hydro / Oleo treatment



Easy cleaning



Preventing stain and fingerprints

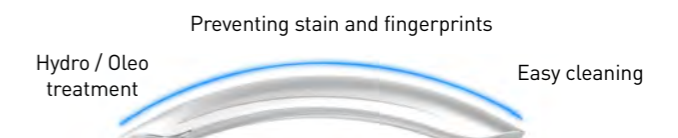



rp optics
technology ■

For particular light conditions, Rudy Project offers technically advanced specialty lenses with high visual quality tailored to your needs. The various lenses enable you to perform and excel in any light or atmospheric condition you may encounter. RP Optics is a design philosophy that aims to improve visual performance and eye protection by means of selective lenses with high optical and mechanical performance, combined with the most advanced technologies and scientific applications. Our lens program has features common to every type of lens, such as neutralizing ultraviolet radiation completely up to 400 nm (UV 400 Protection), and maintains colors integrity even with the dark filters. We believe it is not enough to protect the eyes from hazardous radiation and external agents. It also important to enhance visual acuity and minimize distortion, while offering high quality optics suitable for sports. In some extreme conditions an athlete must rely on technologies to enhance performance and minimize distractions. For this reason, we have expanded the range of filters with specific treatments including antifog, hydrophobic, and photochromic technology.

ALWAYS AT THE FOREFRONT OF TECHNOLOGY, OUR LENSES GUARANTEE VISUAL ACUITY AND PHYSICAL PROTECTION OF THE EYE. HIGH VISUAL QUALITY LENSES HAVE THE FOLLOWING PROPERTIES/BENEFITS:

• reduce glare / enhance contrast



• protect from ultraviolet rays

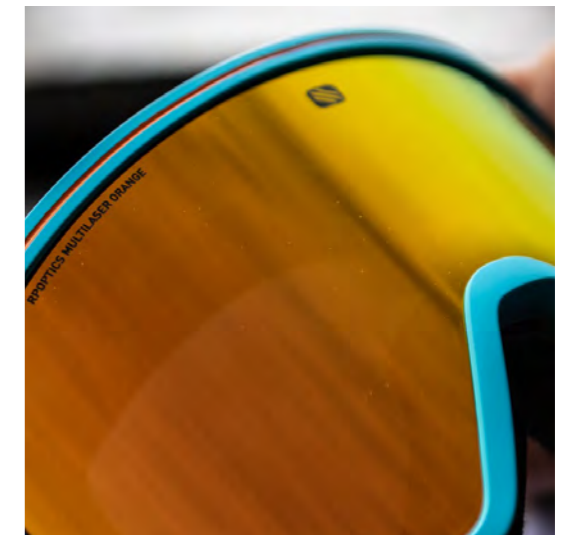

• protect against external agents.





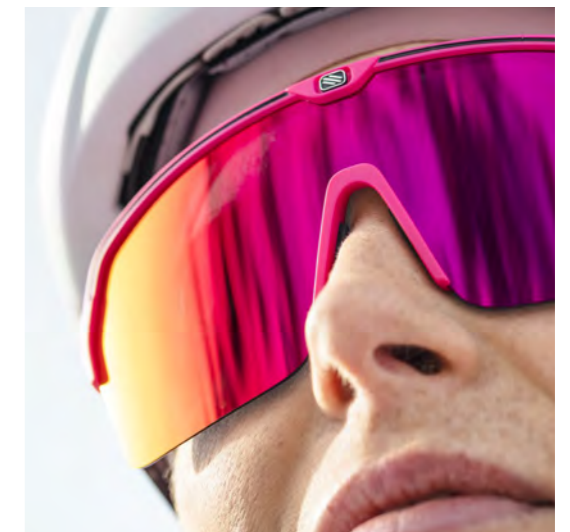



















• ensure true vision without distortion of colors





THIS TABLE ILLUSTRATES THE STANDARDS OF LUMINOUS TRANSMITTANCE OF ALL THE RP OPTICS LENSES. THE VALUES SLIGHTLY VARY FROM THE BENCHMARK SHOWN IN THE TABLE ACCORDING TO THE LENS MODEL. PLEASE REFER TO THE PACKAGING LABEL FOR THE EXACT FIGURES.

 ACTION BROWN 18% Cat.3 ☀️ ☁️ ☁️ LE 22	 SMOKE BLACK 11% Cat.2 ☀️ ☁️ ☁️ LE 10
 GREEN 11% Cat.3 ☀️ ☁️ ☁️ LE 01	 SMOKE BLACK DEG 13% Cat.3 ☀️ ☁️ ☁️ LE 51
 HI-ALTITUDE not suitable for driving 5% Cat.4 ☀️ LE 98	 TRANSPARENT 91% Cat.0 ☀️ ☁️ ☁️ ☆ LE 11
 LASER BLACK 11% Cat.3 ☀️ LE 09	 MULTILASER OSMIUM 15% Cat.3 ☀️ ☁️ ☁️ ☁️ LE 34
 LASER GREEN 22% Cat.3 ☀️ LE 32	 MULTILASER YELLOW 10% Cat.3 ☀️ ☁️ ☁️ ☁️ LE 05
 MULTILASER ORANGE 13% Cat.3 ☀️ ☁️ ☁️ LE 40	 MULTILASER RED 15% Cat.3 ☀️ LE 38
 MULTILASER BLUE 13% Cat.3 ☀️ ☁️ ☁️ LE 39	 MULTILASER ROSE 14% Cat.3 ☀️ LE 67
 MULTILASER DEEP BLUE 17% Cat.3 ☀️ ☁️ ☁️ LE 58	 MULTILASER SUNSET 14% Cat.3 ☀️ LE 52
 MULTILASER GOLD 14% Cat.3 ☀️ ☁️ ☁️ LE 57	 MULTILASER VIOLET 12,2% Cat.3 ☀️ LE 42
 MULTILASER GREEN 14% Cat.3 ☀️ ☁️ ☁️ LE 41	 RACING RED 36,9% Cat.2 ☀️ ☁️ ☁️ ☁️ LE 03
 MULTILASER ICE 13% Cat.3 ☀️ LE 68	 YELLOW 84% Cat.0 ☀️ ☁️ ☁️ ☁️ LE 12

rp optics collection lens

RUDY PROJECT SUNGLASSES ARE LOADED WITH FEATURES THAT MAXIMIZE YOUR COMFORT AND PERFORMANCE. HERE IS A LIST OF TECHNICAL SOLUTIONS THAT MAKE OUR SUNGLASSES THE BEST-IN-THE-WORLD. ON EVERY PRODUCT PAGE OF THE CATALOGUE YOU WILL FIND ICONS THAT REPRESENT THESE FEATURES.



technology features



ADAPTIVE TIPS

The Adaptive Tips system is designed to ensure maximum comfort : thanks to its interior bendable stainless steel, the front portion of the tip can be very easily adjusted and the rear portion of the tip naturally flexes without hurting the riders' head when inserted through the helmet vents



ADJUSTABLE NOSEPIECE

Our soft adjustable nose pads offer an exceptional custom fit for any shape of face



ADJUSTABLE TEMPLE

Adjustable temples ensures a fully custom and a perfect grip maximizing the stability of the sunglasses.



COMPRESSION FIT

The wraparound geometry of the Rudy Project performance eyewear delivers a natural compression fit without applying too much pressure on the head increasing comfort and stability



CUSTOM PROGRAM

The Rudy Project custom program allows you to choose from thousands of different component combinations and to create our personalized look



COUNTER MASK

The vented and padded full-face counter mask provides additional protection from wind and atmospheric elements increasing the safety of the eyes area.



QUICK CHANGE

The Quick Change feature allows you to easily and swiftly change out lenses to manage any light condition and choose the look that suits you best



INTERCHANGEABLE BUMPER

The bumpers are colorful rubber inserts placed on the lower edge of the lens and designed to maximize your safety in the event of crash



TOTAL COMFORT FIT

Featuring ergonomic design, complete adjustability, multiple sizes and smart comfort solutions, our eyewear ensure unparalleled comfort and fit with the psysical features of each ethnic group.



VENT CONTROLLER

Rudy Project vent controller is designed to adjust the airflow through the lens to reduce thermal shock, prevent misting, and ensure perfect vision and comfortable ventilation.



ELASTIC STRAP

The elastic strap with included head lock is essential to secure your eyewear and retain it while wearing a helmet



POWERFLOW

The Power Flow ventilation system reduces the risk of fogging thanks to venting scientifically located on the frame, lens, and temple tips.



PERIPHERAL SHIELDS

The peripheral shields are removable rubber inserts which enhance protection from side light and shocks caused by eventual falls or impacts with rocks or branches.



RX-ABLE

Most of our models offer prescription solutions to always ensure the best standard of performance for all prescription wearers.



SAFETY PROJECT

Rudy Project eyewear provide superior safety through integrated hinges and soft, thermoplastic elastomers which prevent injuries in the event of falls, impact and collisions.



GRAPHENE

Lighter than carbon but stiffer than diamond, graphene boasts unique multi-functional molecular properties: ultra resistance, anti-scratch superiority and exceptional stability while achieving a superb semi-polished deep grey finish naturally obtained during injection moulding, making every single piece one of a kind.



RILSAN

RILSAN® material is used for injecting frame, made from the oil of the castor bean grown in the Gujarat region of India. The oil is further refined during several steps to produce the primary bio-based raw material in the polymer.

performance eyewear ■

Rudy Project equipment is thoughtfully designed to provide athletes with a competitive advantage in training and racing. Our lens quality is unmatched, thanks to technologies that ensure superior clarity and safety for all sports and conditions. Our frames are lightweight, ventilated, and adjustable, which allows for maximum comfort and customization of fit.

E L E V A T E Y O U R P E R F O R M A N C E

©CHARLY LOPEZ





agent q.

o: 1,38 g:39
BASE 8



made in Italy



COUNTER MASK



ELASTIC STRAP



PERIPHERAL SHIELDS

RX SOLUTIONS



RX OPTICAL INSERT
D>87
FR 07 00 00

REPLACEMENT LENSES

IMPACTX®
LE 70 73 03 ImpactX® Photochromic 2 Black
LE 70 72 03 ImpactX® Photochromic 2 Laser Crimson

RP OPTICS
LE 70 11 03 Transparent
LE 70 40 03 Multilaser Orange
LE 70 57 03 Multilaser Gold
LE 70 98 03 Hi-Altitude

ACCESSORIES

GOGGLE INTERFACE/ SIDE SHIELDS- KIT

AC 56 00 46 black matte

AC 56 00 46 B blue avio/grey

ELASTIC STRAP

AC 56 00 45 black

AC 56 00 45B blue navy

AC 56 00 450 olive matte

ELASTIC STRAP CONFIGURATION



road mtb run hiking golf padel water shooting winter

IMPACTX®



BLACK MATTE
ImpactX® Photochromic 2 Laser Crimson
SP 70 72 06 - 0000
ELASTIC STRAP AND SHIELD INTERFACE INCLUDED

RP OPTICS



OLIVE MATTE
Multilaser Gold
SP 70 57 13 - 0000
ELASTIC STRAP AND SHIELD INTERFACE INCLUDED



BLUE NAVY MATTE
Multilaser Orange
SP 70 40 47 - 0000
ELASTIC STRAP AND SHIELD INTERFACE INCLUDED



BLACK MATTE
Hi-Altitude
SP 70 98 06 - S003
ELASTIC STRAP AND SHIELD INTERFACE INCLUDED



Multilaser Gold lenses + Transparent lenses INCLUDED

AGENT Q STEALTH

o:0,91 g: 26 BASE 8



BLACK MATTE
ImpactX® Photochromic 2 Black
SP 70 73 06 - SH00
* CERTIFIED Z87.1



BLACK MATTE
Smoke Black
SP 70 10 06 - SH00
* CERTIFIED Z87.1

* FOR FURTHER INFORMATION - P. 59

FEATURES

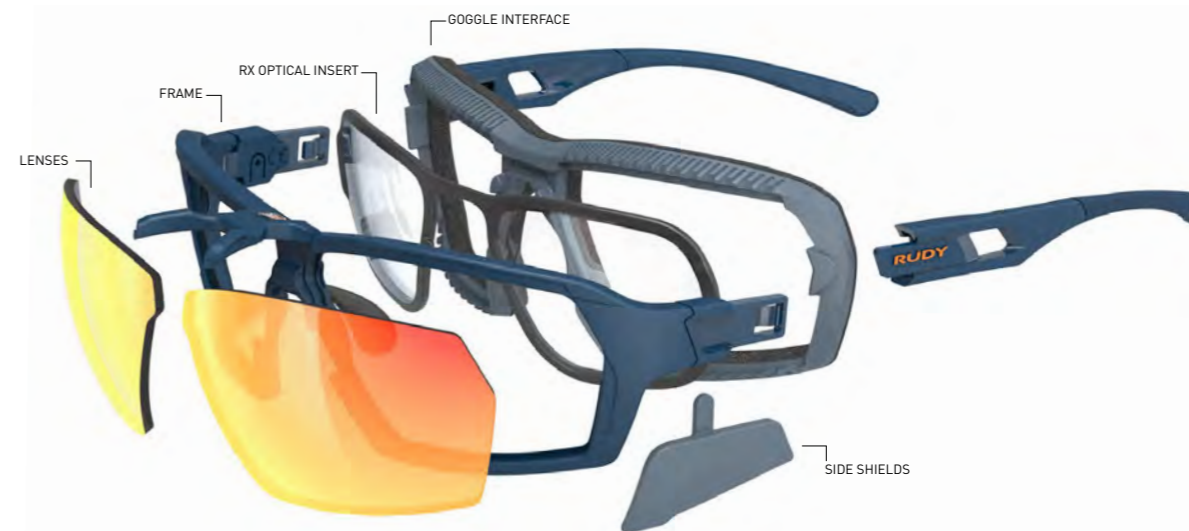



NEW **kelion.**

made in italy

o: 1,27 g: 36
BASE 5.2

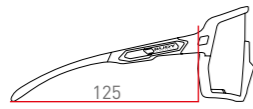
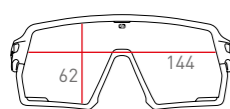

RX SOLUTIONS



RX OPTICAL INSERT
D > 87
FR 84 00 00

REPLACEMENT LENSES

IMPACTX@

LE 85 78 03 ImpactX@ Photochromic 2 Laser Black
LE 85 75 03 ImpactX@ Photochromic 2 Laser Purple

RP OPTICS

LE 85 05 03 Multilaser Yellow
LE 85 38 03 Multilaser Red
LE 85 41 03 Multilaser Green
LE 85 52 03 Multilaser Sunset

ACCESSORIES

FP 50 72 00 Temple tips black
FP 85 77 00 Ergonose black



IMPACTX@



BLACK GLOSS
ImpactX@ Photochromic 2 Laser Purple
SP 85 75 42 - 0000



WHITE GLOSS
ImpactX@ Photochromic 2 Laser Purple
SP 85 75 69 - 0000



BLACK GLOSS
ImpactX@ Photochromic 2 Laser Black
SP 85 78 42 - 0000



CRYSTAL BLUE
ImpactX@ Photochromic 2 Laser Black
SP 85 78 77 - 0000

RP OPTICS



OLIVE MATTE
Multilaser Yellow
SP 85 05 13 - 0000



CRYSTAL RED
Multilaser Red
SP 85 38 17 - 0000



CRYSTAL ASH
Multilaser Green
SP 85 41 57 - 0000



PINK FLUO MATTE
Multilaser Sunset
SP 85 52 89 - 0000



cutline.



made in italy



o: 1,27 g: 36
BASE 7

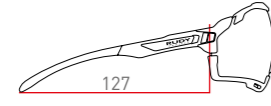
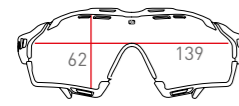

RX SOLUTIONS



POWERFLOW
TOTAL COMFORT FIT



INTERCHANGEABLE
LENS and BUMPER



ADJUSTABLE
NOSEPIECE



ADJUSTABLE
TEMPLE

IMPACTX®



LAGOON MATTE
ImpactX® Photochromic 2 Laser Black
SP 63 78 27 - 0000



CRYSTAL ASH
ImpactX® Photochromic 2 Laser Brown
SP 63 77 57 - 0000



LIGHT GREY MATTE
ImpactX® Photochromic 2 Laser Black
SP 63 78 97 - 0000



MATTE BLACK
ImpactX® Photochromic 2 Black
SP 63 73 06 - 0000



CARBONIUM
ImpactX® Photochromic 2 Red
SP 63 74 19 - 0001



WHITE GLOSS
ImpactX® 2 Laser Purple
SP 63 75 69 - 0008

The photochromic laser coating is developed to reduce lens glare with bright light conditions. Thus, we strongly recommend to use the ImpactX®2 and ImpactRX laser lenses during daylight hours and not at the twilight.

RP OPTICS



WHITE MATTE
Multilaser Red
SP 63 38 78 - 0001



COSMIC BLUE
Multilaser Ice
SP 63 68 94 - 0000



CRYSTAL GLOSS
Multilaser Deep Blue
SP 63 58 96 - 0000

RX SOLUTIONS

impactrx COLLECTION

>84



RX OPTICAL INSERT
>87
FR 39 00 00

REPLACEMENT LENSES

IMPACTX®

- LE 63 73 03 ImpactX® Photochromic 2 Black
- LE 63 74 03 ImpactX® Photochromic 2 Red
- LE 63 75 03 ImpactX® Photochromic 2 Laser Purple
- LE 63 77 03 ImpactX® Photochromic 2 Laser Brown
- LE 63 78 03 ImpactX® Photochromic 2 Laser Black

RP OPTICS

- LE 63 11 03 Transparent
- LE 63 38 03 Multilaser Red
- LE 63 57 03 Multilaser Gold
- LE 63 58 03 Multilaser Deep Blue
- LE 63 68 03 Multilaser Ice

ACCESSORIES

- FP 50 72 00 Temple tips black
- FP 39 77 08 00 V Ergonose IV black
- FP 63 58 00 Upper Bumper Black
- FP 63 68 00 Lower Bumper Black

Cutline features 4 different bumpers configurations to meet the riders demands and to customize your look.

NO BUMBERS



UPPER BUMPER



LOWER BUMPER



FULL CONFIGURATION





defender.



made in italy

o: 1 g: 28
BASE 7

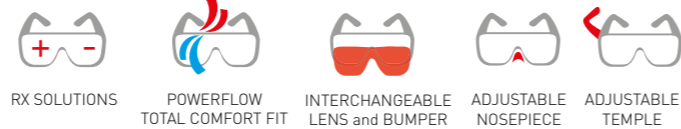
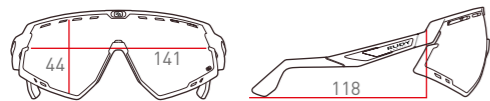

RX SOLUTIONS

RX OPTICAL INSERT
>87
FR 52 00 00

REPLACEMENT LENSES

IMPACTX®

- LE 52 73 03 ImpactX® Photochromic 2 Black
- LE 52 74 03 ImpactX® Photochromic 2 Red
- LE 52 75 03 ImpactX® Photochromic 2 Laser Purple
- LE 52 78 03 ImpactX® Photochromic 2 Laser Black

RP OPTICS

- LE 52 05 03 Multilaser Yellow
- LE 52 10 03 Smoke Black
- LE 52 11 03 Transparent
- LE 52 38 03 Multilaser Red
- LE 52 40 03 Multilaser Orange
- LE 52 68 03 Multilaser Ice

ACCESSORIES

FP 52 72 00 Temple tips black



road mtb run hiking golf padel water shooting winter

IMPACTX®

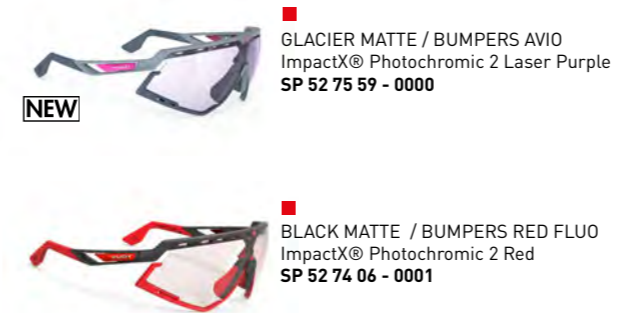

NEW

GLACIER MATTE / BUMPERS AVIO
ImpactX® Photochromic 2 Laser Purple
SP 52 75 59 - 0000

BLACK MATTE / BUMPERS RED FLUO
ImpactX® Photochromic 2 Red
SP 52 74 06 - 0001



PYOMBO MATTE / BUMPERS BLACK
ImpactX® Photochromic 2 Black
SP 52 73 75 - 0000

SAND MATTE / BUMPERS BLACK
ImpactX® Photochromic 2 Laser Black
SP 52 78 32 - 0000

RP OPTICS



NEW

OLIVE MATTE
Multilaser Yellow
SP 52 05 13 - 0000



BLACK MATTE / BUMPERS BLACK
Smoke Black
SP 52 10 06 - 0000

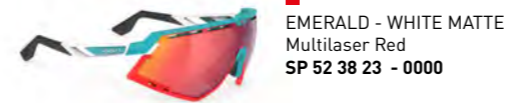

EMERALD - WHITE MATTE
Multilaser Red
SP 52 38 23 - 0000



BLACK MATTE / OLIVE ORANGE STRIPES
BUMPERS OLIVE
Multilaser Orange
SP 52 40 06 - 0020



WHITE GLOSS / FADE BLUE
BLUE RED STRIPES / BUMPERS WHITE
Multilaser Ice
SP 52 68 69 - 0020



tralyx + .

made in Italy

o: 1,06 g: 30
BASE 7

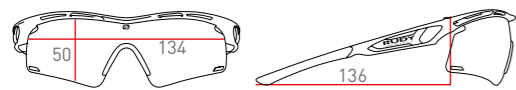

RX SOLUTIONS



POWERFLOW
TOTAL COMFORT FIT



QUICK CHANGE



ADJUSTABLE
NOSEPIECE



ADAPTIVE
TIPS

RX SOLUTIONS

COLLECTION

>84



RX OPTICAL INSERT

>87

FR 39 00 00

REPLACEMENT LENSES

IMPACTX®

- LE 76 73 03 ImpactX® Photochromic 2 Black
- LE 76 75 03 ImpactX® Photochromic 2 Laser Purple
- LE 76 77 03 ImpactX® Photochromic 2 Laser Brown
- LE 76 78 03 ImpactX® Photochromic 2 Laser Black
- LE 76 89 03 ImpactX® Photochromic 2 Laser Red

RP OPTICS

- LE 76 10 03 Smoke Black
- LE 76 11 03 Transparent
- LE 76 40 03 Multilaser Orange
- LE 76 68 03 Multilaser Ice

ACCESSORIES

- FP 76 72 00 Temple tips black
- FP 39 77 08 00 V Ergonose IV black

IMPACTX®



■ LIGHT GREY MATTE
ImpactX® Photochromic 2 Black
SP 76 73 97 - 0000



■ ■ WHITE GLOSS
ImpactX® Photochromic 2 Laser Purple
SP 76 75 69 - 0000



■ CRYSTAL ASH
ImpactX® Photochromic 2 Laser Brown
SP 76 77 57 - 0000



■ BLACK MATTE
ImpactX® Photochromic 2 Laser Black
SP 76 78 06 - 0001



■ ■ ■ ■ BLACK MATTE
ImpactX® Photochromic 2 Laser Red
SP 76 89 06 - 0000

RP OPTICS



■ BLACK MATTE
Smoke Black
SP 76 10 06 - 0001



■ AZUR MATTE
Multilaser Orange
SP 76 40 86 - 0000



■ PACIFIC BLUE MATTE
Multilaser Ice
SP 76 68 49 - 0000

road mtb run hiking golf padel water shooting winter



tralyx + slim.

made in italy

o: 1,02 g: 29
BASE 7

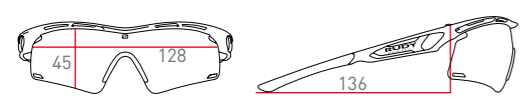

- RX SOLUTIONS
- POWERFLOW
TOTAL COMFORT FIT
- QUICK CHANGE
- ADJUSTABLE
NOSEPIECE
- ADAPTIVE
TIPS

RX SOLUTIONS

RX OPTICAL INSERT
D>87
FR 39 00 00

REPLACEMENT LENSES

- IMPACTX®**
- LE 78 73 03** ImpactX® Photochromic 2 Black
 - LE 78 75 03** ImpactX® Photochromic 2 Laser Purple
 - LE 78 78 03** ImpactX® Photochromic 2 Laser Black
 - LE 78 89 03** ImpactX® Photochromic 2 Laser Red

RP OPTICS

- LE 78 42 03** Multilaser Violet
- LE 78 57 03** Multilaser Gold

ACCESSORIES

- FP 76 72 00** Temple tips black
- FP 39 77 08 00 V** Ergonose IV black

IMPACTX®

- 

BLACK MATTE
ImpactX® Photochromic 2 Black
SP 78 73 06 - 0001
- 

WHITE GLOSS
ImpactX® Photochromic 2 Laser Purple
SP 78 75 69 - 0000
- 

BLACK MATTE
ImpactX® Photochromic 2 Laser Red
SP 78 89 06 - 0000

RP OPTICS

- 

CRYSTAL ASH
Multilaser Violet
SP 78 42 57 - 0000
- 

WHITE GLOSS
Multilaser Gold
SP 78 57 69 - 0001



magnus.

made in italy

o: 1,02 g: 29
BASE 8

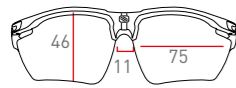

RX SOLUTIONS

impactrx COLLECTION
☑ >84

OPTICAL DOCK
☑ >89
FR 53 OD 87

RX OPTICAL INSERT
☑ >87
FR 70 00 00

REPLACEMENT LENSES

IMPACTX®

- LE 75 73 03** ImpactX® Photochromic 2 Black
- LE 75 74 03** ImpactX® Photochromic 2 Red
- LE 75 75 03** ImpactX® Photochromic 2 Laser Purple
- LE 75 89 03** ImpactX® Photochromic 2 Laser Red

RP OPTICS

- LE 75 10 03** Smoke Black
- LE 75 39 03** Multilaser Blue
- LE 75 57 03** Multilaser Gold

ACCESSORIES

- FP 50 72 00** Temple tips black
- FP 45 77 00 V1** Ergonose XI black

road mtb run hiking golf padel water shooting winter

IMPACTX®



RP OPTICS





helmet:
NYTRON | Pink FLuo- Black Matte
eyewear:
KELION | Pink FLuo - Black Matte



stardash.

made in italy

o: 1,38 g:39
BASE 8

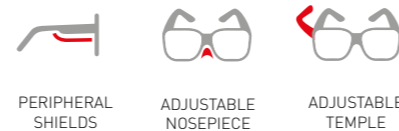
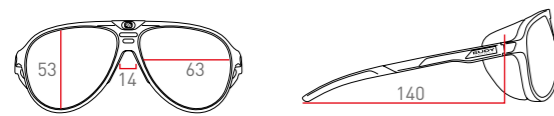

RX SOLUTIONS

RX OPTICAL INSERT
D >87
FR 70 00 00

ACCESSORIES

FP 81 62 00 Side Shields black
FP 39 77 08 00 V Ergonose IV black

IMPACTX®



RP OPTICS



SIDE SHIELD CONFIGURATION



NO SIDE SHIELD CONFIGURATION





rydon. 

made in Italy



o: 0,91 g: 26
BASE 8



RX SOLUTIONS



TOTAL COMFORT FIT



ADJUSTABLE NOSEPIECE



QUICK CHANGE



ADJUSTABLE TEMPLE

RX SOLUTIONS

impactrx COLLECTION
□ >84

 RX DIRECT CLIPS
□ >96
FR 80 00 02 A

 OPTICAL DOCK
□ >89
FR 79 0D 87

 RX OPTICAL INSERT
□ >87
FR 70 00 00

 READERS COLLECTION
□ >97

REPLACEMENT LENSES

IMPACTX®
LE 79 73 ImpactX® Photochromic 2 Black
LE 79 74 ImpactX® Photochromic 2 Red
LE 79 75 ImpactX® Photochromic 2 Laser Purple
LE 79 75 G ImpactX® Photochromic 2 Laser Purple GOLF
LE 79 78 ImpactX® Photochromic 2 Laser Black
LE 79 89 ImpactX® Photochromic 2 Laser Red







POLAR 3FX / HDR
LE 79 59 X Polar3FX Grey
LE 79 61 Polar 3FX HDR Multilaser Green
LE 79 65 Polar 3FX HDR Multilaser Blue

RP OPTICS
LE 79 03 Racing Red
LE 79 08 Laser Copper
LE 79 09 Laser Black
LE 79 10 Smoke Black
LE 79 11 Transparent
LE 79 12 Yellow
LE 79 22 Action Brown
LE 79 34 Multilaser Osmium
LE 79 38 Multilaser Red
LE 79 39 Multilaser Blue
LE 79 40 Multilaser Orange
LE 79 58 Multilaser Deep Blue

ACCESSORIES

FP 53 72 00 Temple tips black
FP 39 77 08 00 V Ergonose IV black



IMPACTX®

-  LIGHT GREY MATTE
ImpactX® Photochromic 2 Laser Purple
SP 53 75 97 - 0000
 -  CARBONIUM
ImpactX® Photochromic 2 Laser Red
SP 53 89 19 - 0000
 -  FROZEN ASH
ImpactX® Photochromic 2 Laser Black
SP 53 78 87 - 0000
 -  FROZEN ASH
ImpactX® Photochromic 2 Red
SP 53 74 87 - 0002
 -  BLACK MATTE
ImpactX® Photochromic 2 Laser Purple
SP 53 75 06 G 00 00
 -  MATTE BLACK
ImpactX® Photochromic 2 Black
SP 53 73 06-SH00
- * CERTIFIED Z87.1+

-  PACIFIC BLUE MATTE
ImpactX® Photochromic 2 Black
SP 53 73 49 - 0000
-  WHITE CARBONIUM
ImpactX® Photochromic 2 Black
SP 53 73 21 - 0000
-  BLACK MATTE
ImpactX® Photochromic 2 Black
SP 53 73 06 - 0000
-  PACIFIC BLUE MATTE
ImpactX® Photochromic 2 Red
SP 53 74 49 - 0R00

* FOR FUTHER INFORMATION - P. 59

POLAR 3FX / HDR

-  BLACK MATTE
Polar3FX Grey
SP 53 59 06 - 0000
-  CARBON
Polar 3FX HDR Multilaser Green
SP 53 61 14 - 0000
-  CARBON
Polar 3FX HDR Multilaser Blue
SP 53 65 14 - 0000

RP OPTICS

-  GLACIER MATTE
Multilaser Osmium
SP 53 34 59 - 0000
-  CRYSTAL ASH
Multilaser Deep Blue
SP 53 58 57 - 0001
-  BLACK MATTE
Smoke Black
SP 53 10 06 - 0000
-  Laser Black
SP 53 09 06 - 0000
-  GRAPHITE MULTICOLOR RED
Multilaser Red
SP 53 38 98 - 0001
-  BLUE NAVY MATTE
Multilaser Blue
SP 53 39 47 - 0000
-  CARBON
Smoke Black
SP 53 10 14 - 0000
-  BLACK MATTE
Racing Red
+ Laser Copper
+ Action Brown
+ Yellow
+ Transparent
SP 53 03 06 - S005

MATTE BLACK
Smoke Black
SP 53 10 06 - SH10
* CERTIFIED Z87.1

* FOR FUTHER INFORMATION - P. 59 51



rydon slim.

made in italy



o: 0,88 g: 25
BASE 8

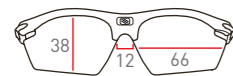

RX SOLUTIONS



TOTAL COMFORT FIT



ADJUSTABLE NOSEPIECE



QUICK CHANGE



ADJUSTABLE TEMPLE

RX SOLUTIONS

impactrx COLLECTION

>84



OPTICAL DOCK

>89

FR 54 0D 87



RX OPTICAL INSERT

>87

FR 70 00 00

REPLACEMENT LENSES

IMPACTX®

- LE 54 73 03 ImpactX® Photochromic 2 Black
- LE 54 75 03 ImpactX® Photochromic 2 Laser Purple
- LE 54 78 03 ImpactX® Photochromic 2 Laser Black
- LE 54 89 03 ImpactX® Photochromic 2 Laser Red

RP OPTICS

- LE 54 10 03 Smoke Black
- LE 54 11 03 Transparent
- LE 54 34 03 Multilaser Osmium
- LE 54 38 03 Multilaser Red
- LE 54 39 03 Multilaser Blue
- LE 54 52 03 Multilaser Sunset
- LE 54 57 03 Multilaser Gold

ACCESSORIES

- FP 53 72 00 Temple tips black
- FP 39 77 08 00 V Ergonose IV black

IMPACTX®



LIGHT GREY MATTE
ImpactX® Photochromic 2 Laser Purple
SP 54 75 97 - 0000



WHITE CARBONIUM
ImpactX® Photochromic 2 Black
SP 54 73 21 - 0000



FROZEN ASH
ImpactX® Photochromic 2 Laser Black
SP 54 78 87 - 0000



BLACK GLOSS
ImpactX® Photochromic 2 Black
SP 54 73 42 - 0000



PACIFIC BLUE MATTE
ImpactX® Photochromic 2 Black
SP 54 73 49 - 0000



BLACK MATTE
ImpactX® Photochromic 2 Black
SP 54 73 06 - 0000



CARBONIUM
ImpactX® Photochromic 2 Laser Red
SP 54 89 19 - 0000

POLAR 3FX / HDR



BLACK MATTE
Polar 3FX Grey
SP 54 59 06 - 0000

RP OPTICS



CRYSTAL ASH
Multilaser Sunset
SP 54 52 57 - 0001



GLACIER MATTE
Multilaser Osmium
SP 54 34 59 - 0000



WHITE GLOSS
Multilaser Gold
SP 54 57 69 - 0000



BLACK MATTE
Smoke Black
SP 54 10 06 - 0000



spinshield.



JOGGING
URBAN
BEACH SPORT

o:0,9 g:26
BASE 5

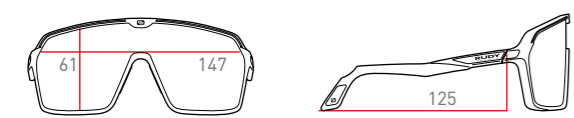

IMPACTX®

- NEW**
WHITE MATTE
ImpactX® Photochromic 2 Laser Purple
SP 72 75 58 - 0005
- NEW**
BLACK MATTE
ImpactX® Photochromic 2 Laser Black
SP 72 78 06 - 0003

- NEW**
PACIFIC BLUE MATTE
ImpactX® Photochromic 2 Laser Black
SP 72 78 49 - 0000

RP OPTICS

- NEW**
CRYSTAL AZUR
Multilaser Green
SP 72 41 68 - 0000
- LIGHT GREY MATTE
Smoke Black
SP 72 10 97 - 0000
- WHITE/PINK FLUO MATTE
Multilaser Red
SP 72 38 58 - 0004
- WHITE/WATER MATTE
Multilaser Orange
SP 72 40 58 - 0003
- BLACK MATTE
Multilaser Blue
SP 72 39 06 - 0002
- BLACK MATTE
Smoke Black
SP 72 10 06 - 0000
- BLACK MATTE
Multilaser Red
SP 72 38 06 - 0002
- WHITE MATTE
Multilaser Gold
SP 72 57 58 - 0000

spinshield air.

JOGGING
URBAN
BEACH SPORT

o:0,9 g:26
BASE 5

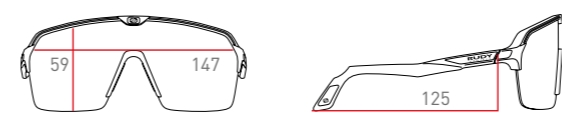

RX SOLUTIONS

RX OPTICAL INSERT
D > 87
FR 84 00 00



IMPACTX®

- NEW**
WHITE MATTE
ImpactX® Photochromic 2 Laser Purple
SP 84 75 58 - 0001

- NEW**
BLACK MATTE
ImpactX® Photochromic 2 Laser Black
SP 84 78 06 - 0003

RP OPTICS

- BLACK MATTE
Smoke Black
SP 84 10 06 - 0000
- PINK FLUO MATTE
Multilaser Red
SP 84 38 90 - 0001
- CRYSTAL ASH
Multilaser Orange
SP 84 40 33 - 0000
- BLACK MATTE
Multilaser Red
SP 84 38 06 - 0002
- BLACK MATTE
Multilaser Blue
SP 84 39 06 - 0003
- WHITE MATTE
Multilaser Gold
SP 84 57 58 - 0000



NEW **astral.**

made in italy

o: 0,88 g: 26
BASE 6

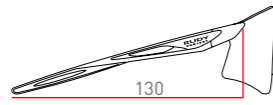
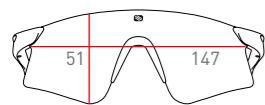

RX SOLUTIONS



RX OPTICAL INSERT
□ >87
FR 84 00 00

ACCESSORIES

FP 39 77 08 00 V1 Ergonose IV black



road mtb run hiking golf padel water shooting winter

RP OPTICS



■ **BLACK MATTE**
Smoke
SP 88 10 06 - 0000



■ **WHITE MATTE**
Multilaser Blue
SP 88 39 58 - 0000



■ **EMERALD FADE GLOSS**
Multilaser Orange
SP 88 40 71 - 0000



■ **CRYSTAL ASH**
Multilaser Green
SP 88 41 33 - 0000



■ **METAL TITANIUM MATTE**
Multilaser Sunset
SP 88 52 92 - 0000



■ **PINK FLUO FADE GLOSS**
Multilaser Ice
SP 88 68 90 - 0000



NEW **sirius.**



made in italy

o: 1,1 g: 30
BASE 8

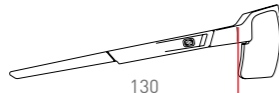
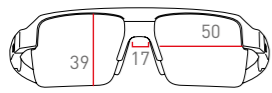

POWERFLOW
TOTAL COMFORT FIT



ADJUSTABLE
NOSEPIECE



ADJUSTABLE
TEMPLE

RX SOLUTIONS

impactrx COLLECTION

>84



RX OPTICAL INSERT

>87

FR 49 00 00



RX OPTICAL DOCK

>87

FR 87 0D 06

REPLACEMENT LENSES

IMPACTX®

- LE 87 73 03 ImpactX® Photochromic 2 Black
- LE 87 75 03 ImpactX® Photochromic 2 Laser Purple
- LE 87 78 03 ImpactX® Photochromic 2 Laser Black

POLAR 3FX / HDR

- LE 87 59 03 Polar3FX Grey

RP OPTICS

- LE 87 10 03 Smoke
- LE 87 38 03 Multilaser Red
- LE 87 42 03 Multilaser Violet
- LE 87 52 03 Multilaser Sunset

ACCESSORIES

- FP 87 72 00 Temple tips black
- FP 85 77 00 Ergonose black



road mtb run hiking golf padel water shooting winter

IMPACTX®



BLACK MATTE
ImpactX® Photochromic 2 Black
SP 87 73 06 - 0000



WHITE GLOSS
ImpactX® Photochromic 2 Laser Purple
SP 87 75 69 - 0000



COSMIC BLUE
ImpactX® Photochromic 2 Laser Black
SP 87 78 94 - 0000

POLAR 3FX / HDR



BLACK MATTE
Polar 3FX Grey
SP 87 59 06 - 0000

RP OPTICS



BLACK MATTE
Smoke
SP 87 10 06 - 0000



WHITE GLOSS
Multilaser Red
SP 87 38 69 - 0000



CRYSTAL ASH
Multilaser Violet
SP 87 42 57 - 0000



BLACK MATTE
Multilaser Sunset
SP 87 52 06 - 0001



deltabeat.

made in italy

o: 1,09 g: 31
BASE 8

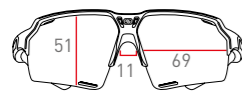

RX SOLUTIONS



OPTICAL DOCK
□ >89
FR 74 0D 87



RX OPTICAL INSERT
□ >87
FR 70 00 00

REPLACEMENT LENSES

IMPACTX®

- LE 74 73 03 ImpactX® Photochromic 2 Black
- LE 74 74 03 ImpactX® Photochromic 2 Red
- LE 74 75 03 ImpactX® Photochromic 2 Laser Purple

RP OPTICS

- LE 74 10 03 Smoke Black
- LE 74 38 03 Multilaser Red
- LE 74 40 03 Multilaser Orange
- LE 74 52 03 Multilaser Sunset
- LE 74 68 03 Multilaser Ice



road mtb run hiking golf padel water shooting winter

IMPACTX®



BLACK MATTE
ImpactX® Photochromic 2 Black
SP 74 73 06 - 0000



LIGHT GREY
ImpactX® Photochromic 2 Black
SP 74 73 97 - 0000



CHARCOAL MATTE
ImpactX® Photochromic 2 Red
SP 74 74 38 - 0000



WHITE GLOSS
ImpactX® Photochromic 2 Laser Purple
SP 74 75 69 - 0000

RP OPTICS



CRYSTAL ASH
Multilaser Sunset
SP 74 52 33 - 0000



WHITE EMERALD MATTE
Multilaser Orange
SP 74 40 58 - 0000



BLACK MATTE
Smoke Black
SP 74 10 06 - 0000



PACIFIC BLUE MATTE
Multilaser Ice
SP 74 68 49 - 0000



CHARCOAL MATTE
Multilaser Red
SP 74 38 38 - 0000



propulse.



made in italy

o: 0,9 g: 26
BASE 8

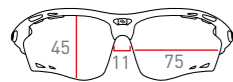

RX SOLUTIONS



COMPRESSION FIT



ADJUSTABLE NOSEPIECE



QUICK CHANGE



VENT CONTROLLER

RX SOLUTIONS

impactrx COLLECTION

>84



RX OPTICAL INSERT

>87

FR 70 00 00

REPLACEMENT LENSES

IMPACTX®

- LE 62 73 03 ImpactX® Photochromic 2 Black
- LE 62 74 03 ImpactX® Photochromic 2 Red
- LE 62 75 03 ImpactX® Photochromic 2 Laser Purple

RP OPTICS

- LE 62 09 03 Laser Black
- LE 62 10 03 Smoke Black
- LE 62 11 03 Transparent
- LE 62 38 03 Multilaser Red
- LE 62 40 03 Multilaser Orange
- LE 62 58 03 Multilaser Deep Blue

ACCESSORIES

- FP 62 72 00 Temple tips black
- FP 45 77 00 V 1 Ergonose IV black



road mtb run hiking golf padel water shooting winter

IMPACTX®



LIGHT GREY MATTE
ImpactX® Photochromic 2 Black
SP 62 73 97 - 0000



BLACK MATTE
ImpactX® Photochromic 2 Black
SP 62 73 06 - 0000



PACIFIC BLUE MATTE
ImpactX® Photochromic 2 Red
SP 62 74 49 - 0000



BLACK MATTE
ImpactX® Photochromic 2 Red
SP 62 74 06 - 0000



WHITE GLOSS
ImpactX® Photochromic 2 Laser Purple
SP 62 75 69 - 0000

RP OPTICS



WHITE GLOSS
Laser Black
SP 62 09 69 - 0000



BLACK MATTE
Smoke Black
SP 62 10 06 - 0000



CHARCOAL MATTE
Multilaser Red
SP 62 38 38 - 0000



BLUE NAVY MATTE
Multilaser Orange
SP 62 40 47 - 0000



CRYSTAL ASH
Multilaser Deep Blue
SP 62 58 33 - 0000



TECHNICAL FEATURES

guard collection.

GUARD

made in italy



AGENT Q GUARD

o: 1,38 g:39
BASE 8

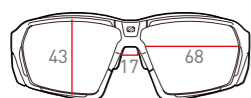

BLACK MATTE
Transparent Z87+/EN166
SP 70 11 06 - GRD0

CERTIFIED Z87.1 / EN 166:2001

TRALYX GUARD

o: 1,09 g:31
BASE 7

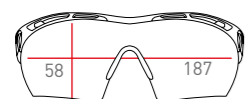

CRYSTAL GLOSS
Transparent Z87+/EN166
SP 39 11 96 - GRD0

CERTIFIED Z87.1+ / EN 166:2001

INTRON GUARD

o: 0,9 g:25
BASE 8

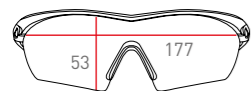

BLACK GLOSS
Transparent Z87+/EN166
SP 25 11 42 - GRD0

CERTIFIED Z87.1+ / EN 166:2001



P.P.E CERTIFIED CATEGORY 2

All Rudy Project protective glasses are PPE certified in compliance with the EN 166:2001 Standard on eye protection. Agent Q Guard Tralyx Guard and Intron are both category 2 PPE. The PPE eyewear meets also the ANZI Z87+ standards passing the high mass impact and high velocity impact tests ensuring further protection



SHIELD PROTECTIVE LENSES

All the PPE eyewear feature specific lens geometry to maximize the protection of the eyes area. The PPE eyewear lenses are more deep and wraparound compared to the traditional lens shapes. The transparent polycarbonate lenses benefit from the RP Optics qualities such as sharp vision and high resistance.



COMFORT AND STABILITY

Drawing from the Rudy Project performance features, our PPE frames feature soft rubber adjustable temple tips and nose pads to offer maximum comfort, stability and adjustability.



INTERCHANGEABLE RETAINER

Tralyx Guard features an interchangeable retainer with head lock included to keep your spectacles safe.



EASY CLEANING

Our PPE collection sunglasses are easy to sanitize with warm water, mild soap or with a hydrogen peroxide solution at 0.5%.



WATER AND CHEMICAL RESISTANCE

The Grilamid frame of the Rudy Project glasses is well suited to cleaning and sterilization. Thanks to its high chemical resistance this material can be cleaned and sanitized several times without being damaged.



LIGHTNESS AND DURABILITY

Benefiting from the Grilamid frame and its ergonomic design, all the Rudy Project PPE glasses are extremely comfy without exerting any pressure on the skull.



PPE CATEGORY 2

PPE Cat. 2 eyewear is designed to be worn or held by an individual for protection against one or more health and safety hazards. Each eye protection equipment (PPE) used for work-related purposes must at least be classified as category 2 in compliance with the Standard UNI EN 166:2001. Therefore, for this kind of glasses, third-part testing is mandatory.



SPLASH AND LIQUID DROPLET PROTECTION

Agent Q ensures a superior level of protection because it meets the requirements of the UNI EN 166:2001 (PPE category 2) and the additional standard of splash and liquid droplets protection in compliance with the specific testing procedure of the UNI EN 168:2001 (point 12).



WHAT IS Z87.1

ANSI Z87.1 is the American National Standard that covers the basic requirements for personal eye and face protective devices to minimize or prevent injuries from impacts, non-ionizing radiation and chemical agents in occupational, educational and military environments. This Standard sets criteria related to the description, general requirements, testing, marking, selection, care and use of these protectors.

+ is an additional requirement of ANSI Z87.1 standard which provides more strict and severe impact tests:

Penetration (1.56 oz – 44.2 gm / 50 in – 127 cm)
High Mass Impact (17.6 oz – 500 gr / 50 in – 127 cm)

High Velocity Impact resistance (150 ft/s – 46 m/s).

active lifestyle ■

Rudy Project's Active Lifestyle collection weaves a spectrum of colors and inspirational designs into our DNA of premium sports performance. Developed around style and comfort, this collection optimizes optical clarity, thanks also to our POLAR 3FX and HDR technologies.

E L E V A T E Y O U R P E R F O R M A N C E





lightflow a.

JOGGING
URBAN
BEACH SPORT

lightflow b.

JOGGING
URBAN
BEACH SPORT

o:1,2 g:31
BASE 6

o:1,1 g:29
BASE 6

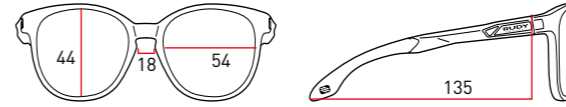
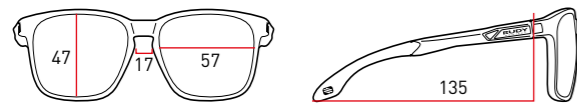

RP OPTICS

RP OPTICS



POLAR 3FX / HDR

POLAR 3FX / HDR



ACCESSORIES

ACCESSORIES

- FP 56 72 00 Temple tips black
- FP 56 78 00 Z Ergonose black Slim configuration
- FP 56 78 00 ZZ Ergonose black Regular configuration

- FP 56 72 00 Temple tips black
- FP 56 78 00 Z Ergonose black Slim configuration
- FP 56 78 00 ZZ Ergonose black Regular configuration



NEW stellar.

JOGGING ———
 URBAN ———
 BEACH SPORT ———

o:0,75 g:21
 BASE 6



overlap.

JOGGING ———
 URBAN ———
 BEACH SPORT ———

o:0,88 g:25
 BASE 6

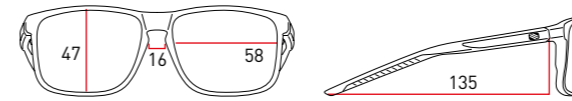

RP OPTICS



DEMI BROWN GLOSS
 Green
 SP 91 01 10 - 0000



BLACK MATTE
 Smoke Black
 SP 91 10 06 - 0000



WHITE MATTE
 Smoke Black
 SP 91 10 58 - 0000



CRYSTAL AZUR
 Multilaser Green
 SP 91 41 68 - 0000



CRYSTAL GLOSS
 Multilaser Sunset
 SP 91 52 96 - 0000



CRYSTAL GLOSS
 Multilaser Sunset
 SP 77 52 96 - 0000



BLACK GLOSS
 Smoke Black
 SP 77 10 42 - 0000



ICE BLUE METAL MATTE
 Multilaser Red
 SP 77 38 53 - 0000



OLIVE METAL MATTE
 Multilaser Orange
 SP 77 40 36 - 0000



CHARCOAL MATTE
 Multilaser Gold
 SP 77 57 38 - 0000



BLACK FADE CRYSTAL AZUR GLOSS
 Multilaser Ice
 SP 77 68 42 - 0011

POLAR 3FX / HDR



BLACK MATTE
 Polar 3FX Grey
 SP 91 59 06 - 0000



BLACK MATTE
 Polar3FX Grey
 SP 77 59 06 - 0000



CRYSTAL ASH
 Polar3FX HDR Multilaser Green
 SP 77 61 33 - 0000



spinair 57.

JOGGING
URBAN
BEACH SPORT

o:1,1 g:32
BASE 6



RP OPTICS



POLAR 3FX / HDR

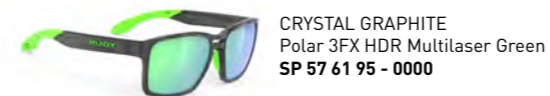

ACCESSORIES

- FP 56 72 00 Temple tips black
- FP 56 78 00 Z Ergonose black Slim configuration
- FP 56 78 00 ZZ Ergonose black Regular configuration



spinhawk.

JOGGING —
 URBAN —
 BEACH SPORT —

o:1 g:30
 BASE 6



RP OPTICS



OLIVE MATTE
 Laser Green
 SP 31 32 13 - 0000



CHARCOAL MATTE
 Multilaser Gold
 SP 31 57 38 - 0000



BLACK FADE CRYSTAL
 AZUR GLOSS
 Multilaser Ice
 SP 31 68 42 - 0010



CARBONIUM
 Multilaser Red
 SP 31 38 19 - 0000



MATTE BLACK
 Smoke Black Deg
 SP 31 51 06

POLAR 3FX / HDR



BLACK MATTE
 Polar3FX Grey
 SP 31 59 06 X



soundrise.

JOGGING —
 URBAN —
 BEACH SPORT —

o:0,96 g:27
 BASE 6



RP OPTICS



CRYSTAL GLOSS
 Multilaser Blue
 SP 13 39 96 - 0000



BLACK FADE BRONZE MATTE
 Multilaser Orange
 SP 13 40 06 - 0010



BLACK FADE CRYSTAL AZUR GLOSS
 Multilaser Ice
 SP 13 68 42 - 0011



BLACK GLOSS
 Smoke Black
 SP 13 10 42 - 0000



BLACK MATTE / ICE GOLD PATTERN
 Multilaser Gold
 SP 13 57 06 - 0003

POLAR 3FX / HDR



BLACK MATTE
 Polar 3FX HDR Multilaser Red
 SP 13 62 06 - 0001



BLACK MATTE
 Polar 3FX Grey
 SP 13 59 06 - 0002



skytrail.

JOGGING
URBAN
BEACH SPORT

o:1,30 g:37
BASE 6

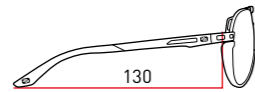
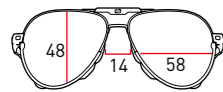

RP OPTICS



LIGHT GOLD SHINY
Green
ML 38 01 05 - 0000



ALUMINUM MATTE
Multilaser Orange
ML 38 40 01 - 0000



ALUMINUM MATTE
Multilaser Ice
ML 38 68 01 - 0001



ALUMINUM MATTE
Laser Black
ML 38 09 01 - 0000



GUN MATTE
Smoke Black Deg
ML 38 51 02 - 0000

POLAR 3FX / HDR



GUN MATTE
Polar3FX Grey
ML 38 59 02 - 0000



croze.

JOGGING
URBAN
BEACH SPORT

o:0,95 g:27
BASE 6

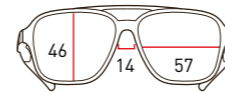

RP OPTICS



BLACK MATTE
Smoke Black
SP 67 10 06 - 0000



DEMI TURTLE GLOSS
Green
SP 67 01 50 - 0000



rx|optical ■

Rudy Project prioritizes optical clarity and coverage when developing RX optical eyewear for athletes. We offer a wide range of optical solutions for athletes. The process begins with understanding the specific demands of the athlete to create the most technologically advanced eyewear in the world.

H I - T E C H S P O R T P R E S C R I P T I O N



rx solutions.



rx direct

THE ULTIMATE OPTION

- the world's most advanced digital surface lenses
- fully personalised
- Maximum impact resistance
- Stylish wraparound design
- Superior eye comfort (absence of distortions)
- photochromic or polarized lenses



rx inserts

THE VALUE OPTION

- Easy to mount and interchangeable
- Perfect for lower budgets
- Allows opticians to edge prescription lenses in the office
- Available on all performance models
- Perfect for contact lens wearers



rx optical dock

THE HIGH CORRECTION SPORT OPTION

- Easy to mount and interchangeable
- Perfect for sport high prescriptions
- Available in our top selling performance models
- allows opticians to edge prescription lenses in the office
- full rim interchangeable design
- built to last



rx direct clips

THE UTILITY OPTION

- Easy to mount and interchangeable allows opticians to edge prescription lenses in the office
- Perfect for high prescriptions
- Ideal for contact lens wearers who want another option for when eyes become irritated
- High versatility of interchangeable clear and sun RX lenses in the same frame
- Adapts perfectly to different contexts



rx readers

THE INTEGRATED READING OPTION

- Perfect for people with presbyopic correction needs
- Helps to read - maps, smart/mobile devices, hear rate monitors, score cards, etc..
- PC bifocal lenses available in 3 powers and 3 vibrant multilayer colours



rx flip-up

THE VERSATILE OPTION

- Perfect for high prescriptions and versatile sun protection
- Allows instant control over light transmission
- Designed for sport but ideal for any occasion
- Driving friendly
- Allows opticians to edge prescription lenses in the office



rx ophthalmic

THE PRESCRIPTION OPTION

- Inspired from our performance models features but with the casual touch
- Allows opticians to edge prescription lenses in the office

quick optical guide.

EYEWEAR	PATENTED QUICK INSERT TECHNOLOGY ON ADAPTER	impactrx RP OPTICS highindex	RX OPTICAL INSERT	RX OPTICAL DOCK	RX DIRECT CLIPS
AGENT Q		■	FR 07 00 00 A 35 / B 49 DBL 23 BASE 5		
ASTRAL			FR 84 00 00 A 42 / B 56 DBL 14 BASE 5		
CUTLINE		ONLY FOR CUTLINE INSET WITH IMPACTRX	FR 39 00 00 A 50 / B 33 DBL 13 BASE 5		
DEFENDER			FR 52 00 00 A 57 / B 37 DBL 13 BASE 6		
DELTABEAT			FR 70 00 00 A 45 / B 33 DBL 20 BASE 6	FR 74 OD 87- A 52 / B 43 DBL 20 BASE 4	
MAGNUS		■	FR 70 00 00 A 45 / B 33 DBL 20 BASE 6	FR 53 OD 87- A 52 / B 38 DBL 20 BASE 6	
PROPULSE		■	FR 70 00 00 A 45 / B 33 DBL 20 BASE 6		
RYDON		■	FR 70 00 00 A 45 / B 33 DBL 20 BASE 6	FR 79 OD -- A 54 / B 34 DBL 20 BASE 4	FR 80 00 02 A A 60 / B 38 DBL 21 BASE 8
RYDON SLIM			FR 70 00 00 A 45 / B 33 DBL 20 BASE 6	FR 54 OD -- A 51 / B 34 DBL 20 BASE 4	
SIRIUS		■	FR 49 00 00 A 47 / B 34 DBL 22 BASE 5	FR 87 OD 06 A 40 / B 35 DBL 21 BASE 6	
SPINSHIELD AIR			FR 84 00 00 A 42 / B 56 DBL 14 BASE 5		
STARDASH			FR 70 00 00 A 45 / B 33 DBL 20 BASE 6		
TRALYX + TRALYX SLIM +		ONLY FOR TRALYX+ INSET WITH IMPACTRX	FR 39 00 00 A 50 / B 33 DBL 13 BASE 5		
GOOGLE					
SKERMO			FR 12 00 00 A 54 / B 49 DBL 19 BASE 6		
SPINCUT			FR 12 00 00 A 54 / B 49 DBL 19 BASE 6		



rx direct
impactrx ■

impactrx 2black

☞ 74% - 9% | Cat.1/3



NAKED EYES

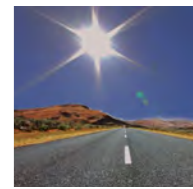

ACTIVATED

impactrx 2laserblack

☞ 62% - 13% | Cat.1/3



NAKED EYES

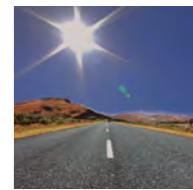

ACTIVATED

impactrx 2red HDR

☞ 76% - 17% | Cat.1/3



NAKED EYES

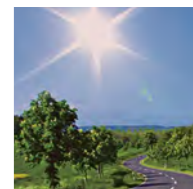

ACTIVATED

impactrx 2laserred HDR

☞ 75% - 16% | Cat.1/3



NAKED EYES

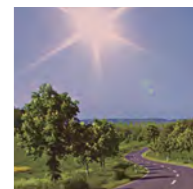

ACTIVATED

impactrx 2laserpurple HDR

☞ 48% - 8% | Cat.1/3

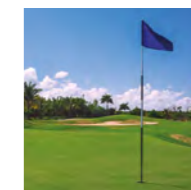

NAKED EYES

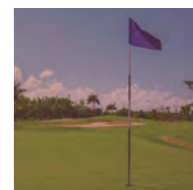

ACTIVATED

impactrx 2laserbrown HDR

☞ 73% - 17% | Cat.1/3

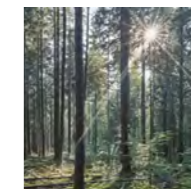

NAKED EYES



ACTIVATED

Offering freeform single vision and progressive lens design for performance sport wraps, ImpactRX® is the world's most advanced digital back surface lens program, fully personalized for your lifestyle. We've combined a revolutionary lens material with the best wrap design to create the best prescription sports lens in the world! Now available in many superlative platforms. For more information please contact your country official Rudy Project distributor (<http://www.rudyproject.com/customer-service/distributors/>) or send an email to rudyrx@rudyproject.com to receive your personal web credentials. Once activated you can immediately place orders.

WARNING The content of this catalog section is dedicated exclusively to opticians and qualified healthcare operators. Therefore, in compliance with the Italian legislation, I declare under my own responsibility that I am a qualified professional in the optical and/or ophthalmology sector and I am allowed to have access to this content.

RP optics high index.

OUR 1.6 ENTRY MATERIAL OF CHOICE FOR PATIENTS WITH HIGH PRESCRIPTIONS, OR WHEN LENS THICKNESS CONSIDERATION IS ESSENTIAL

Rudy Project created a new and innovative Hybrid material, dedicated to patients with stronger prescriptions: the ImpactRx High Index combines the best attributes of High Index, such as its extraordinary thinness, to the comfort of ImpactRX, offering strength and durability.

Main features include:

- LOWER DENSITY TO PROVIDE LIGHTER LENSES AND INCREASED COMFORT
- ENHANCED IMPACT RESISTANCE (UP TO 5 TIMES WHEN COMPARED TO OUR PREVIOUS HI-1.6 MATERIAL)
- IMPROVED COSMETIC FOR WRAP LENSES
- THINNER THAN COMMON HIGH INDEX 1.60 MATERIALS (UP TO 5%)



TECHNICAL FEATURES Density gr/cm3 1,23- Refractive index 1,60 - Abbe Number 41 - UV Cutout 400 - Absorption 100% UVA UVB

TRANSPARENT

☞ 90,7% | Cat.0



LASER GOLD

☞ 20% | Cat.3



ACTION BROWN

☞ 10,7% | Cat.3



MULTILASER ORANGE

☞ 17,4% | Cat.3



RACING RED

☞ 32,9% | Cat.2



SMOKE

☞ 18% | Cat.3



LASER BLACK

☞ 18% | Cat.3



MULTILASER BLUE

☞ 18% | Cat.3



Transitions Signature VII

IMPACTRX® HIGH INDEX TRANSITION GREY

☞ 12% - 92% | Cat.0/3

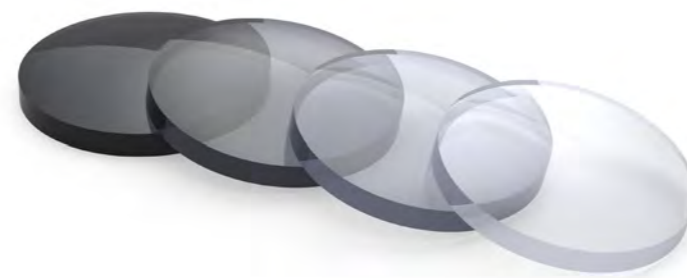

diamond coat



WHAT IS DIAMOND COAT? Diamond Coat is an exceptional and powerful multi-layer coating engineered to eliminate lens glare, ghost images and halos from bright light or back reflections while offering a cleaner vision by preventing dust, water drops, scratches and finger marks on the lens. Perfect for outdoor action and dusty environments, Diamond Coat will keep lenses sparkling and easy to clean. It will ensure a better comfort while providing outstanding lens durability.

The Rudy Project Diamond Coat is a superior treatment resulting from extensive research and provides the following features:

- anti-static layer against dust and impurities
- anti-reflection coating, cutting lens glare, ghosts and halos resulting from bright light
- enhanced protection against finger marks
- superior hydrophobic layers against water drops
- outstanding scratch protection, ensuring lens durability

polar 3FX 1.59.

WHAT IS POLAR 3FX?

POLARIZED LENSES effectively block reflected glare, a situation which occurs primarily near water or snow or off reflective surfaces nearby, such as car windows, metallic objects, etc. Light which strikes a horizontal reflective surface is reflected back into your eyes. You then get a "double dose" of light energy, some of which falls directly on to you and some that is reflected on to you. Polarized lenses offer an interesting advantage: because they dramatically reduce or eliminate the reflected light energy which might account for the majority of the annoying glare, you can use a lighter tint to achieve the same (or better) degree of glare reduction and comfort compared to non-polarized dark lenses.

PATENTED 3FX POLARIZED TECHNOLOGY

POLAR3FX coatings offer:

- Advanced visual acuity, depth of field perception, chromatic partitioning.
- Minimizes annoying staining and smudging for clean, unobstructed vision all the time.
- Highly scratch resistant.
- A unique and sophisticated fashionable look.

DIAMOND COAT INCLUDED

Rudy Project's unique multi-layer process provides excellent visual acuity and eliminates annoying back glare that causes eye strain and eye fatigue in bright light conditions. Reduced hue and ambient reflections.

POLAR 3FX [1.59]

TECHNICAL FEATURES Density gr/cm3 1,20- Refractive index 1,59 - Abbe Number 31 - UV Cutout 385 - Absorption 100% UVA UVB



ANTI-REFLECTION COATING

Lenses with higher indices also reflect more than standard plastic and glass. Because of this, anti-reflective coating is especially important. Additional reflections will be distracting in day to day activities such as night driving and computer use. Impurities, water drops, dust, scratches will heavily influence the comfort of high index lenses, for these reasons, Rudy Project offers diamond coat, our new premium coating.

ATTENTION

For its highly engineered vision solution using extremely sophisticated edging equipments, all models of the ImpactRX and ImpactRX High Index collection are mounted and shipped directly and exclusively through our own laboratories according to selected sunwear geometry and original patient's prescription formula.

POLAR 3FX [1.59] HDR

After years of intense research, we have updated our Polar3FX technology to take your vision to the next level. Polar3FX HDR technology eliminates glare providing superior visual comfort, enhanced contrast and contours. In addition, the new Polar3FX lenses incorporate the HDR (high dynamic range) filter to further define contrast and color perception. To ensure maximum toughness and durability, we have boosted the Polar 3FX lenses with the revolutionary 3FX Coating anti smudge and anti aging treatment.

POLAR 3FX HDR MULTILASER BLUE



POLAR 3FX HDR MULTILASER RED



POLAR 3FX HDR MULTILASER ORANGE



POLAR 3FX HDR MULTILASER GREEN



PROGRESSIVE 15 mm.

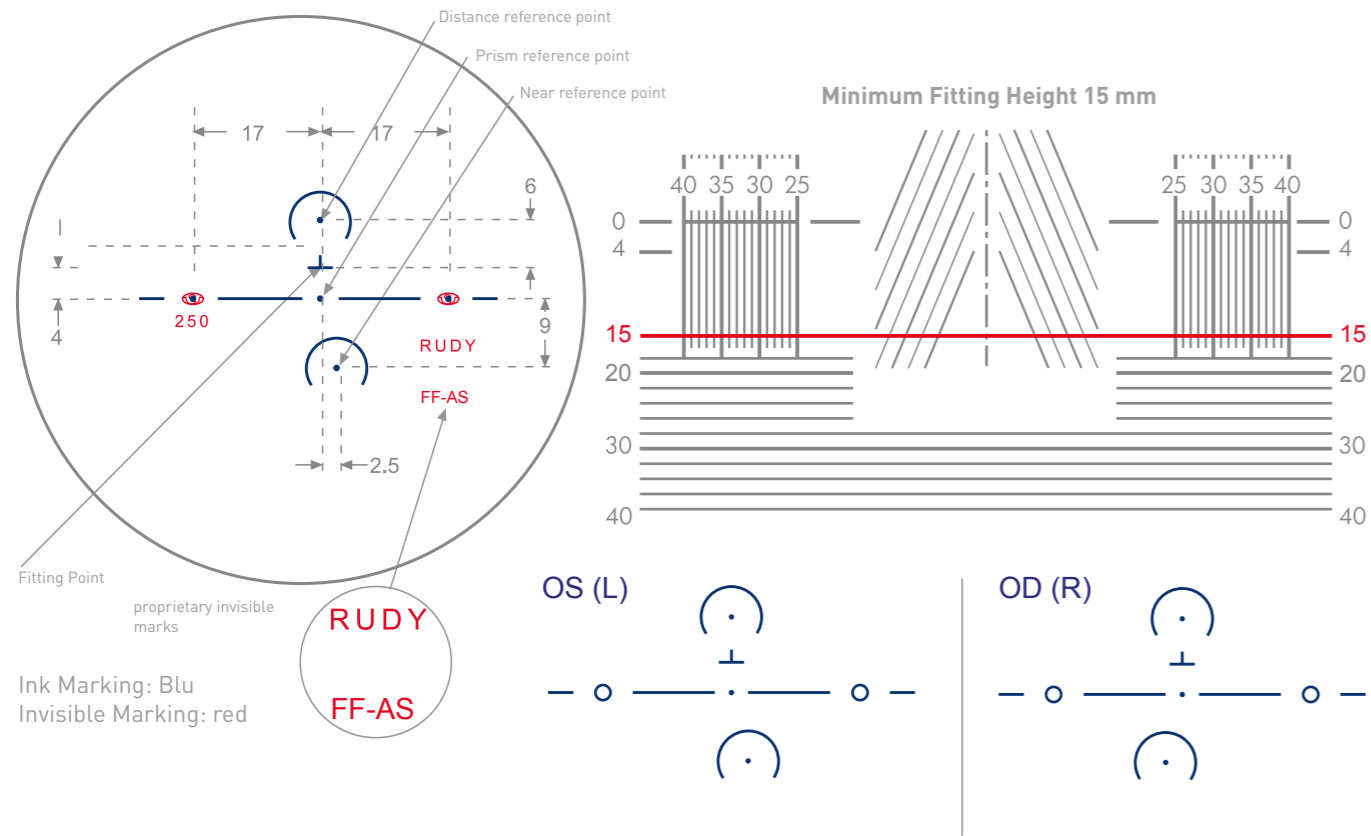

SINGLE VISION

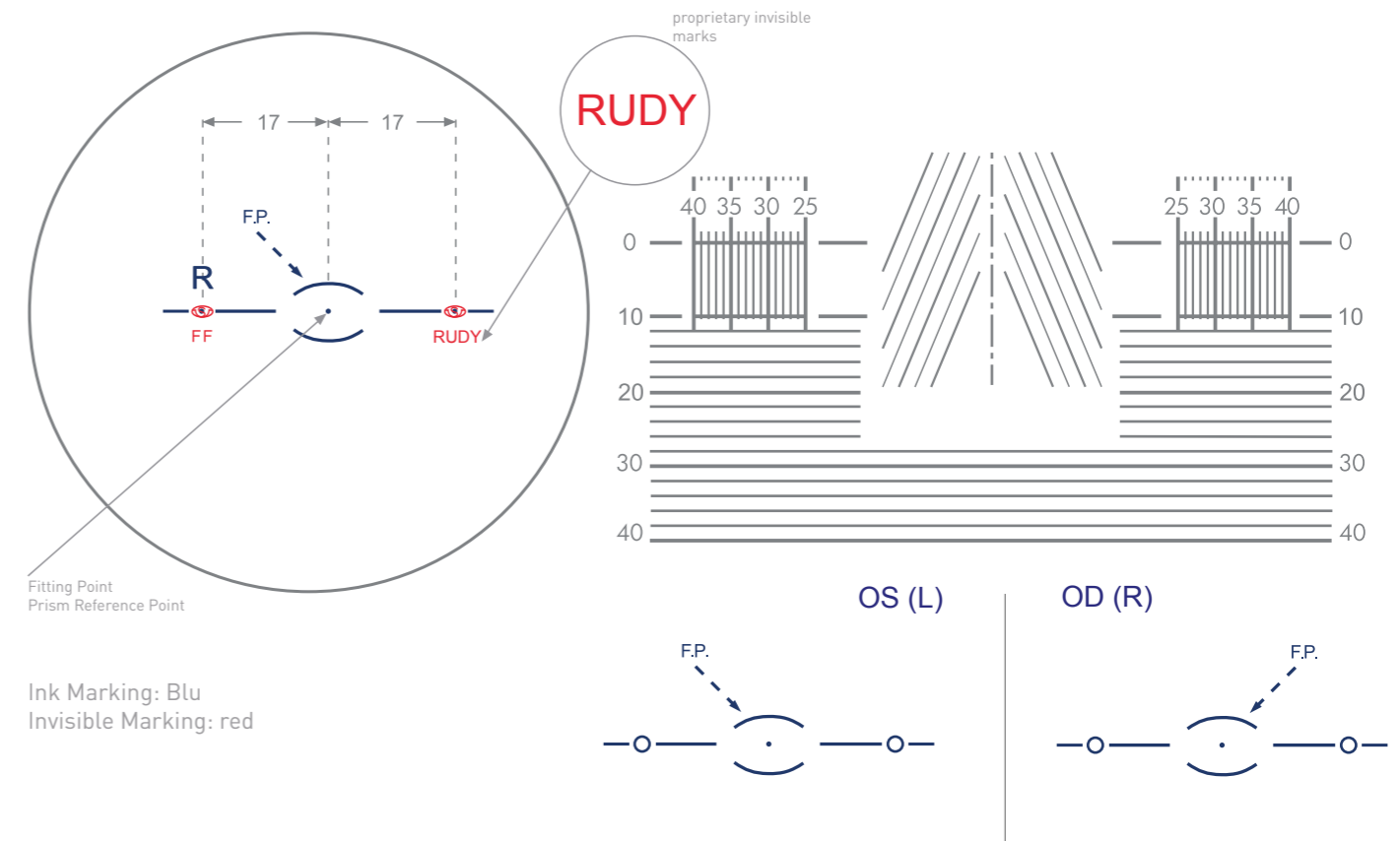

PROGRESSIVE 18 mm.

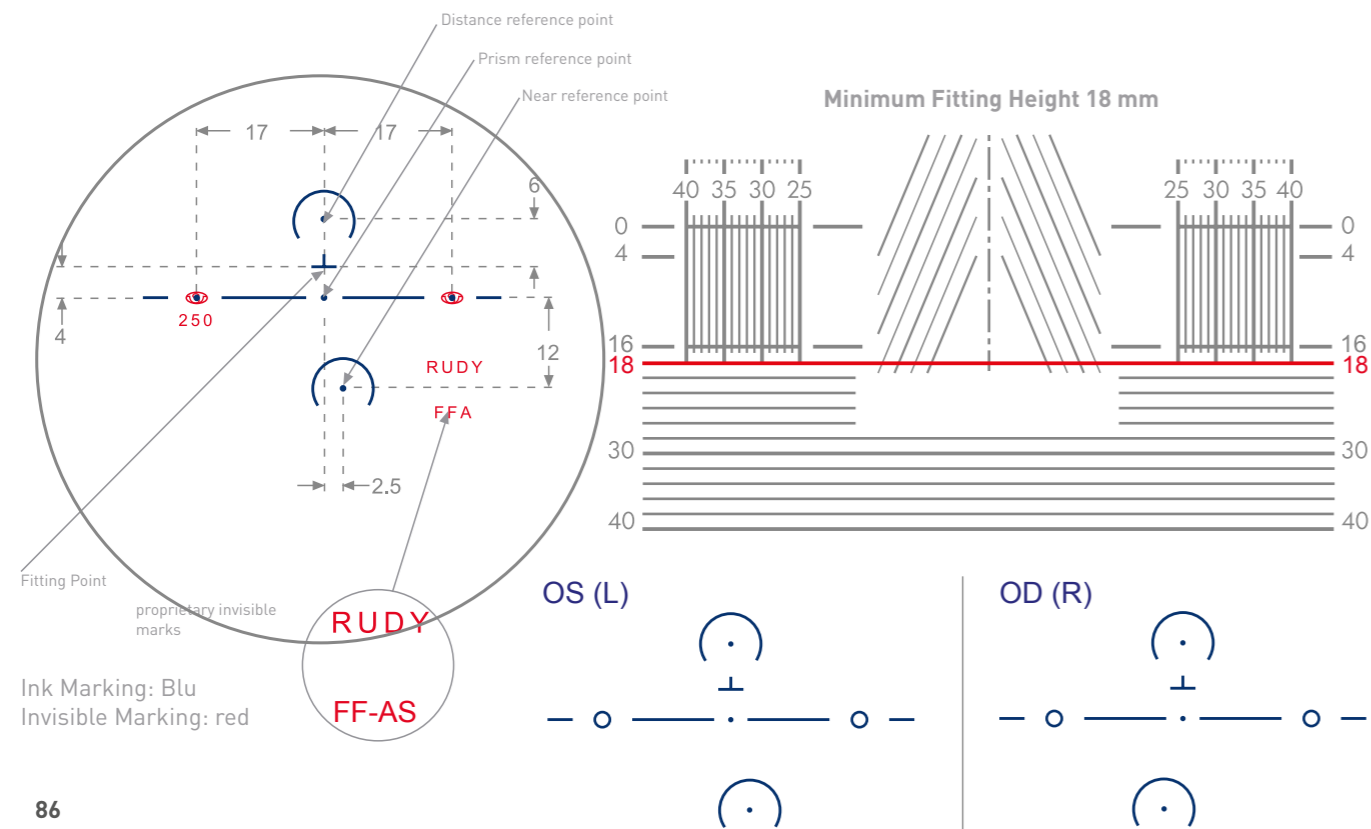

NEW **sirius**

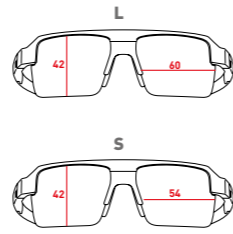

		58	60	62	64	66	68	70
impactrx	Sirius L	60	-3,00+4,50	-3,00+4,75	-3,25+5,25	-3,50+5,50	-3,75+6,00	-3,75+6,75
	Sirius S	54	-3,00+4,75	-3,25+5,00	-3,50+5,25	-3,75+5,75	-4,00+6,25	-4,25+7,25
RP OPTICS highindex	Sirius L	60	-3,50+5,75	-3,75+6,00	-4,00+6,50	-4,25+7,00	-4,50+7,50	-4,50+7,75
	Sirius S	54	-3,50+5,75	-4,00+6,00	-4,25+6,75	-4,50+7,00	-4,75+7,50	-5,00+8,25
POLAR 3FX [1.59]	Sirius L	60	-3,00+2,75	-2,25+3,00	-3,50+3,25	-3,50+3,50	-3,50+3,75	-3,75+4,00
	Sirius S	54	-3,25+3,00	-3,25+3,00	-3,50+3,50	-3,50+3,75	-3,75+4,00	-4,00+4,25
POLAR 3FX [1.59] HDR	Sirius L	60	-3,00+2,75	-2,25+3,00	-3,50+3,25	-3,50+3,50	-3,50+3,75	-3,75+4,00
	Sirius S	54	-3,25+3,00	-3,25+3,00	-3,50+3,50	-3,50+3,75	-3,75+4,00	-4,00+4,25

agent q

weight ounces: 1,38 grams: 39
eye size dbl temple 68 □ 17 — 135 - h 43
base 8

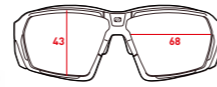

		58	60	62	64	66	68	70
impactrx	Agent Q	68	-2,00+2,00	-2,00+2,00	-2,25+2,25	-2,25+2,25	-2,50+2,25	-2,75+2,50
	Agent Q	68	-2,50+2,50	-2,75+2,50	-3,00+2,75	-3,00+2,75	-3,25+2,75	-3,50+3,00
RP OPTICS highindex	Agent Q	68	-2,50+2,50	-2,75+2,50	-3,00+2,75	-3,00+2,75	-3,25+2,75	-3,50+3,00
	Agent Q	68	-2,50+2,50	-2,75+2,50	-3,00+2,75	-3,00+2,75	-3,25+2,75	-3,50+3,00
POLAR 3FX [1.59] HDR	Agent Q	68	-2,50+2,50	-2,75+2,50	-3,00+2,75	-3,00+2,75	-3,25+2,75	-3,50+3,00
	Agent Q	68	-2,50+2,50	-2,75+2,50	-3,00+2,75	-3,00+2,75	-3,25+2,75	-3,50+3,00

cutline

weight ounces: 1,27 grams: 36
eye size dbl temple 139 — 127 - h 62
base 7



THE HEIGHT MEASUREMENT MUST BE DETECTED FROM THE LOWER EDGE OF THE PLANO LENS

		58	60	62	64	66	68	70
impactrx	Cutline*	62	-3,00 to +2,50	-3,50 to +2,75	-3,75 to +3,00	-4,00 to +3,75	-4,25 to +3,50	-4,50 to +4,00
	Cutline*	62	-3,00 to +2,50	-3,50 to +2,75	-3,75 to +3,00	-4,00 to +3,75	-4,25 to +3,50	-4,50 to +4,00

* AVAILABLE ONLY FOR IMPACTRX PHOTOCROMIC 2 BLACK

magnus

weight ounces: 1,02 grams: 29
eye size dbl temple 75 □ 11 — 133 - h 45
base 8



		58	60	62	64	66	68	70
impactrx	Magnus	75	-1,50+1,50	-1,75+1,50	-2,00+1,75	-2,00+1,75	-2,25+1,75	-2,50+2,00
	Magnus	75	-1,50+1,50	-1,75+1,50	-2,00+1,75	-2,00+1,75	-2,25+1,50	-2,25+1,50
RP OPTICS highindex	Magnus	75	-1,50+1,50	-1,75+1,50	-2,00+1,75	-2,00+1,75	-2,25+1,50	-2,25+1,50
	Magnus	75	-1,50+1,50	-1,75+1,50	-2,00+1,75	-2,00+1,75	-2,25+1,50	-2,25+1,50
POLAR 3FX [1.59]	Magnus	75	-1,50+1,50	-1,75+1,50	-2,00+1,75	-2,00+1,75	-2,25+1,75	-2,50+2,00
	Magnus	75	-1,50+1,50	-1,75+1,50	-2,00+1,75	-2,00+1,75	-2,25+1,75	-2,50+2,00
POLAR 3FX [1.59] HDR	Magnus	75	-1,50+1,50	-1,75+1,50	-2,00+1,75	-2,00+1,75	-2,25+1,75	-2,50+2,00
	Magnus	75	-1,50+1,50	-1,75+1,50	-2,00+1,75	-2,00+1,75	-2,25+1,75	-2,50+2,00

rydon

weight ounces: 0,88 grams: 24
eye size dbl temple 71 □ 12 — 133
base 8

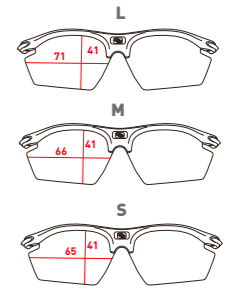

		58	60	62	64	66	68	70
impactrx	Rydon L	71	-2,00+1,75	-2,25+2,00	-2,50+2,25	-2,75+2,25	-3,00+2,50	-3,00+2,75
	Rydon M	66	-2,75+2,50	-3,00+2,75	-3,00+3,00	-3,25+3,00	-3,50+3,25	-3,75+3,50
	Rydon S	64	-3,50+2,75	-3,50+3,00	-3,50+3,25	-3,75+3,50	-3,75+3,75	-4,00+4,00
RP OPTICS highindex	Rydon L	71	-2,25+2,00	-2,50+2,25	-2,75+2,50	-3,00+2,75	-3,25+3,00	-3,50+3,00
	Rydon M	66	-2,75+2,75	-3,00+3,00	-3,25+3,00	-3,50+3,25	-3,75+3,50	-4,25+3,50
	Rydon S	64	-3,50+3,25	-3,50+3,50	-4,00+3,75	-4,25+3,75	-4,50+4,00	-5,00+4,00
POLAR 3FX [1.59]	Rydon L	71	-2,50+2,00	-2,75+2,25	-3,00+2,50	-3,25+2,75	-3,50+3,00	-4,00+3,00
	Rydon M	66	-3,25+2,75	-3,50+3,00	-3,75+3,00	-4,00+3,25	-4,25+3,50	-4,75+3,50
	Rydon S	64	-3,50+3,50	-3,75+3,50	-4,25+3,75	-4,50+3,75	-4,75+4,00	-5,25+4,00
POLAR 3FX [1.59] HDR	Rydon L	71	-2,50+2,00	-2,75+2,25	-3,00+2,50	-3,25+2,75	-3,50+3,00	-4,00+3,00
	Rydon M	66	-3,25+2,75	-3,50+3,00	-3,75+3,00	-4,00+3,25	-4,25+3,50	-4,75+3,50
	Rydon S	64	-3,50+3,50	-3,75+3,50	-4,25+3,75	-4,50+3,75	-4,75+4,00	-5,25+4,00

rydon slim

weight ounces: 0,88 grams: 24
eye size dbl temple 66 □ 12 — 133 - h 40
base 8



		58	60	62	64	66	68	70
impactrx	Rydon Slim	66	-3,50+2,75	-3,50+3,00	-3,50+3,25	-3,75+3,50	-3,75+3,75	-4,50+4,00
	Rydon Slim	66	-3,25+3,50	-3,50+3,50	-4,00+3,75	-4,25+3,75	-4,50+4,00	-5,00+4,00
RP OPTICS highindex	Rydon Slim	66	-3,25+3,50	-3,50+3,50	-4,00+3,75	-4,25+3,75	-4,50+4,00	-5,00+4,00
	Rydon Slim	66	-3,50+3,50	-3,75+3,50	-4,25+3,75	-4,50+3,75	-4,75+4,00	-5,25+4,00
POLAR 3FX [1.59]	Rydon Slim	66	-3,50+3,50	-3,75+3,50	-4,25+3,75	-4,50+3,75	-4,75+4,00	-5,25+4,00
	Rydon Slim	66	-3,50+3,50	-3,75+3,50	-4,25+3,75	-4,50+3,75	-4,75+4,00	-5,25+4,00

tralys +

weight ounces: 0,98 grams: 27,8
eye size dbl temple 134 — 136 - h 52
base 7



THE HEIGHT MEASUREMENT MUST BE DETECTED FROM THE LOWER EDGE OF THE PLANO LENS

		58	60	62	64	66	68	70
impactrx	Tralys +*	54	-3,00 to +2,50	-3,50 to +2,75	-3,75 to +3,00	-4,00 to +3,75	-4,25 to +3,50	-4,50 to +3,75
	Tralys +*	54	-3,00 to +2,50	-3,50 to +2,75	-3,75 to +3,00	-4,00 to +3,75	-4,25 to +3,50	-4,50 to +3,75

* AVAILABLE ONLY FOR IMPACTRX PHOTOCROMIC 2 BLACK

propulse

weight ounces: 0,9 grams: 26
eye size dbl temple 72 □ 11 — 126
base 8

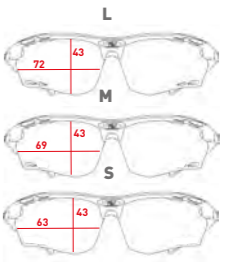

		58	60	62	64	66	68	70
impactrx	Propulse L	72	-1,50+1,25	-1,50+1,25	-1,50+1,50	-1,50+1,50	-1,75+1,50	-2,25+1,50
	Propulse M	69	-2,00+1,75	-2,00+1,75	-2,25+2,25	-2,25+2,25	-2,50+2,25	-2,75+2,25
	Propulse S	63	-2,00+2,25	-2,00+2,25	-2,50+2,25	-2,50+2,25	-2,75+2,25	-3,00+2,50
RP OPTICS highindex	Propulse L	72	-1,50+1,50	-1,75+1,50	-2,00+1,75	-2,00+1,75	-2,25+1,75	-2,50+2,00
	Propulse M	69	-2,50+2,00	-2,75+2,50	-3,00+2,25	-3,00+2,25	-3,25+2,50	-3,50+2,50
	Propulse S	63	-2,50+2,50	-2,75+2,50	-3,00+2,75	-3,25+2,75	-3,50+2,75	-3,75+3,00
POLAR 3FX [1.59]	Propulse L	72	-1,50+1,50	-1,75+1,50	-2,00+1,75	-2,00+1,75	-2,25+1,75	-2,50+2,00
	Propulse M	69	-2,50+2,00	-2,75+2,50	-3,00+2,25	-3,00+2,25	-3,25+2,50	-3,50+2,50
	Propulse S	63	-2,50+2,50	-2,75+2,50	-3,00+2,75	-3,25+2,75	-3,50+2,75	-3,75+3,00
POLAR 3FX [1.59] HDR	Propulse L	72	-1,50+1,50	-1,75+1,50	-2,00+1,75	-2,00+1,75	-2,25+1,75	-2,50+2,00
	Propulse M	69	-2,50+2,00	-2,75+2,50	-3,00+2,25	-3,00+2,25	-3,25+2,50	-3,50+2,50
	Propulse S	63	-2,50+2,50	-2,75+2,50	-3,00+2,75	-3,25+2,75	-3,50+2,75	-3,75+3,00



rx optical inserts

Rudy Project has developed RX inserts that can be easily attached behind the polycarbonate lenses. Our 'easy-in easy-out' system allows for effortless insertion and removal of Clip-ons, making them convenient when you want to wear contact lenses or clean your glasses.

1. If the template is unavailable, use the demo (or plano lens) as a reference for cutting the ophthalmic lenses.
2. Properly shape the clip according to the glasses model before installation. After setting it, determine the fit parameters (PD and H) and make final adjustments when mounting progressive lenses.
3. Be sure to note your references for the true horizontal axis before removing the clip to fit ophthalmic lenses.
4. Keep in mind that the vertex distance is reduced when using an Optical RX insert, and this should be considered before mounting ophthalmic lenses.
5. The winding angle of the RX Optical Insert may vary based on the eyewear's design and geometry. It is usually much higher than that of regular dress eyewear, leading to horizontal prismatic deviation, which increases with lens power. Rudy Project generally recommends applying a horizontal shift of +1.00 mm per eye for negative correction and -1.00 mm per eye for positive correction.
6. For spherical lens values greater than +/- 3:00 diopters and considering the high wrap of Rudy Project frames, make necessary adjustments to accommodate the required horizontal prismatic compensation and reduced vertex distance.
7. Always verify the lens centering on the clip when it's inside the frame before mounting ophthalmic lenses. Avoid mounting prescriptions on clips without a frame.
8. To achieve the best results when mounting lenses on the clip, Rudy Project recommends referring to the patient's regular dress eyewear. This will ensure a quicker and easier adaptation to the new device.
9. Rudy Project advises using ophthalmic lenses with spherical geometry. For optimal performance, consider mounting lenses specifically designed for wraparound frames.



The FR70 RX Optical Insert comes now standard with 3 pairs of proprietary shock absorber stickers; made out of a special polymer they will minimize scratches and vibrations resulting from the insert/correction lenses against the inner surface of the sun/plano lenses. To be mounted on the far edge of each prescription lens of the insert.



OPTICAL CLIP SHOCK ABSORBER KIT (INCLUDED)
6 pcs.
AC 56 00 33 B



KELION WITH FR 84 00 00



rx optical
dock

**INTRODUCING THE ENHANCED HIGH-CORRECTION SPORTS OPTION
EXCEPTIONAL FUNCTIONALITY - OPTIMAL VALUE - STREAMLINED STYLE**

Following years of meticulous research, we've revamped our Optical Dock, one of Rudy Project's most versatile and sought-after sports eyewear solutions, to offer prescription wearers an even more seamless and sophisticated option. The full-rim optical interface boasts a sleek design and broader shape, skillfully blending style with the remarkable adaptability and user-friendliness of the Optical Dock platform. Furthermore, it extends the prescription range for higher correction levels.

The Optical Dock 2 is an effortlessly RX-adaptable 6-Base full-rim clip crafted from a sturdy yet flexible polymer, compatible with any lens material, including entry-level edging processes. Its innovative shape provides an expanded field of view and accommodates a wider variety of prescriptions (both standard and progressive), enabling the correction of vision for higher and more intricate levels in a sleek and integrated package.

Featuring interchangeable clips, the Optical Dock 2 is simple to install, courtesy of a proprietary screwless system, and is fully compatible with our award-winning 'Rydon' model. This cutting-edge solution is ideal for patients requiring significant vision correction who also desire the design, technology, and comfort of Rudy Project sunglasses. It provides opticians with increased flexibility in handling, while offering cost-effective solutions to customers.

SIRIUS



OPTICAL DOCK - BLACK MATTE
optical dock frozen ash
SP87 OD 06 - 0001



only frame
FP 87 00 06 - 0001



only optical dock black matte
(A 40 B 35 DBL 21 BASE 6)



OPTICAL DOCK
FR 87 OD 06 BLACK MATTE

RYDON



optical dock 2 frozen ash - MATTE BLACK
SP 53 OD 06 - 0001
optical dock frozen ash - MATTE BLACK
SP 53 OD 06 - 0000



only frame
FP 53 00 06 - 0000



only optical dock 2
(A 52 B 38 DBL 22 BASE 6)

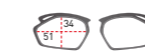

only optical dock
(A 51 B 34 DBL 20 BASE 4)



OPTICAL DOCK 2
FR 53 OD 87 FROZEN ASH



OPTICAL DOCK
FR 79 OD 58 WHITE MATTE



FR 79 OD 87 FROZEN ASH



FR 79 OD 27 LIME MATTE



FR 79 OD 13 RED FLUO MATTE

RYDON SLIM



OPTICAL DOCK - MATTE BLACK
optical dock frozen ash
SP 54 OD 06 - 0000



only frame
FP 54 00 06 - 0000



only optical dock
(A 51 B 34 DBL 20 BASE 4)



OPTICAL DOCK
FR 54 OD 58 WHITE MATTE



FR 54 OD 87 FROZEN ASH



FR 54 OD 27 LIME MATTE



FR 54 OD 13 RED FLUO MATTE

MAGNUS



OPTICAL DOCK 2 - BLACK MATTE
optical dock frozen ash
SP 75 OD 06 - 0000



only frame
FP 75 00 06 - 0000



only optical dock 2 frozen ash
(A 52 B 38 DBL 22 BASE 6)



OPTICAL DOCK 2
FR 53 OD 87 FROZEN ASH

DELTABEAT



OPTICAL DOCK - BLACK MATTE
optical dock frozen ash
SP 74 OD 06 - 0000



only frame
FP 74 00 06 - 0000



only optical dock frozen ash
(A 52 B 43 DBL 18 BASE 4)



OPTICAL DOCK
FR 74 OD 87 FROZEN ASH



rx direct clips

WE ARE THRILLED TO ANNOUNCE THE LATEST ADDITION TO THE RUDY PROJECT FAMILY: OUR INNOVATIVE "DIRECT CLIPS" LINE, DESIGNED SPECIFICALLY FOR CONTACT LENS WEARERS WHO FACE CHALLENGES DURING SPORTS ACTIVITIES OR THOSE WHO REQUIRE A MORE BUDGET-FRIENDLY ALTERNATIVE TO PRESCRIPTION SPORTS SUN LENSES LIKE IMPACTRX. THE DIRECT CLIPS SYSTEM IS A GAME-CHANGER IN THE WORLD OF EYEWEAR, OFFERING A VERSATILE AND COST-EFFECTIVE SOLUTION TO YOUR CUSTOMERS' VISION NEEDS.

With Rudy Project's RX Direct Clips, you can now provide your customers with the convenience of quickly and effortlessly edging prescription lenses right in your office, eliminating the need for complex cutting machines. Our patented smart mounting system allows for easy removal and attachment, making it a breeze for customers to switch between clear and sun RX lenses in the same frame.

Key features of the Direct Clips line include:

- Ease of use: The smart mounting system allows opticians to easily edge prescription lenses in the office, saving time and resources.
- Versatility: Interchangeable clear and sun RX lenses provide customers with the flexibility to adapt their eyewear to various light conditions and activities.
- Budget-friendly: Direct Clips offer a more affordable alternative for customers who are unable to invest in premium prescription sports sun lenses like ImpactRX.
- Ideal for sensitive eyes: Perfect for contact lens wearers who experience irritation during sports practice or other outdoor activities.

By choosing Rudy Project's Direct Clips for your optical practice, you are not only offering your customers a superior eyewear solution but also enhancing their overall experience. This innovative product is sure to set your business apart from the competition and solidify your reputation as a cutting-edge eyewear provider.

Don't miss out on the opportunity to revolutionize your customers' eyewear experience with the Rudy Project Direct Clips line. For more information or to place an order, please contact our dedicated sales team today.



RYDON
black matte frame

frame + direct clip
SP 53 15 06 - V000

only frame
FP 53 00 06 - 0000

only direct clip (A 60 B 39 DBL 21 BASE 8)
FR 80 00 02 A



inkas | inkas xl.

made in italy

o:0,95 g:27

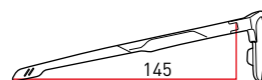

FLIP-UP

- INKAS**
FR 68 89 09 Laser Black
- INKAS XL**
FR 69 89 09 Laser Black
- INKAS**
FR 68 89 10 Smoke
- INKAS XL**
FR 69 89 10 Smoke
- INKAS**
FR 68 89 68 Multilaser Ice
- INKAS XL**
FR 69 89 68 Multilaser Ice

ACCESSORIES

REPLACEMENT NOSEPADS

BLACK
FP 68 77 00



BLUE NAVY
FP 68 77 30



REPLACEMENT TIPS

BLACK
FP 68 72 00



BLUE NAVY
FP 68 72 30



FRAMES

HALF RIM - SHAPE A



INKAS
BLACK MATTE
SP 68 0A 06 - 0000



INKAS
BLUE NAVY MATTE
SP 68 0A 47 - 0000



INKAS
DEMI TURTLE GLOSS
SP 68 0A 50 - 0000

INKAS XL
BLACK MATTE
SP 69 0A 06 - 0000

INKAS XL
BLUE NAVY MATTE
SP 69 0A 47 - 0000

INKAS XL
DEMI TURTLE GLOSS
SP 69 0A 50 - 0000

HALF RIM - SHAPE B



INKAS
BLACK MATTE
SP 68 0B 06 - 0000



INKAS
BLUE NAVY MATTE
SP 68 0B 47 - 0000



INKAS
DEMI TURTLE GLOSS
SP 68 0B 50 - 0000

INKAS XL
BLACK MATTE
SP 69 0B 06 - 0000

INKAS XL
BLUE NAVY MATTE
SP 69 0B 47 - 0000

INKAS XL
DEMI TURTLE GLOSS
SP 69 0B 50 - 0000

FULL RIM



INKAS
BLACK MATTE
SP 68 15 06 - 0000



INKAS
BLUE NAVY MATTE
SP 68 15 47 - 0000



INKAS
DEMI TURTLE GLOSS
SP 68 15 50 - 0000

INKAS CLIPS

FULL RIM



CLIP SIZE 49|40 mm

BLACK MATTE
FR68 00 00

BLUE NAVY MATTE
FR68 00 47

SHAPE A



CLIP SIZE 50|41 mm

LIGHT GUN
FR68 00 02 A

SHAPE B



CLIP SIZE 50|41 mm

LIGHT GUN
FR68 00 02 B

INKAS XL CLIPS

SHAPE A

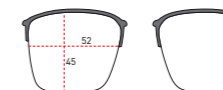

CLIP SIZE 52|45 mm

LIGHT GUN
FR69 00 02 A

SHAPE B

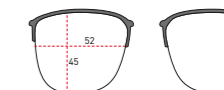

CLIP SIZE 52|45 mm

LIGHT GUN
FR69 00 02 B



maya.



made in italy

o:0,5 g:14
(demo lens)



TECH PILLS

- Nylon mount
- Clip base: 6
- Nylon groove milling: 0,8 mm x 0,8 mm
- We recommend spherical lenses
- Use Trivex, polycarbonate or high index 1.6 lenses

LENS MATERIAL	RECOMMENDED RANGE
index 1.53	- 3,00 + 2,00
index 1.60	- 4,50 + 3,50
index 1.67	- 5,00 + 4,00

The chart offers a general indication on the material of lenses to be used on prescription. The optician has the freedom to decide the final selection on the basis of the real requirements and prescription, fitting parameters (PD & H) and the shape of the lenses chosen.

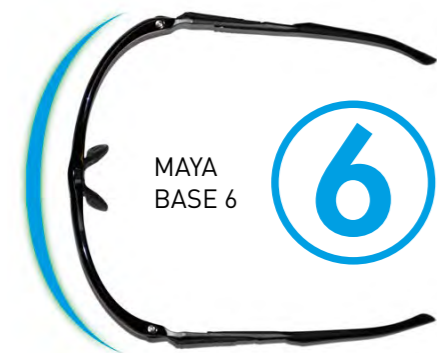

MAYA

- Sturdy design
- High wrap
- Sport adjustable nosepiece
- Kynetium optical removable clips

REPLACEMENT LENSES

IMPACTX®

LE 12 73 03 ImpactX® Photochromic 2 Black

RP OPTICS

LE 12 38 03 Multilaser Red

LE 12 09 03 Laser Black

LE 12 10 03 Smoke Black

LE 12 03 03 Racing Red

LE 12 11 03 Transparent

LE 12 12 03 Yellow

REPLACEMENT TIPS

FR 66 72 00 Black

FR 66 72 03 Red

FR 66 72 04 Brown

FR 66 72 05 Orange

FR 66 72 09 White

FR 66 72 20 Yellow

FR 66 72 31 Blue avio

FRAMES



GRAPHITE / BLACK
color 11



CRYSTAL PINK / WHITE
color 13



BLACK GLOSS / BLACK
color 16



GRAPHITE / YELLOW
color 18

CLIPS



SHAPE A 53 | 29 mm

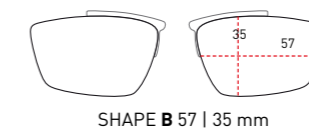

SHAPE B 57 | 35 mm

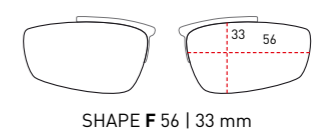

SHAPE F 56 | 33 mm

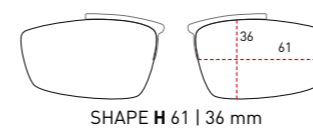

SHAPE H 61 | 36 mm

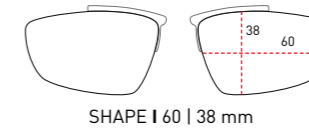

SHAPE I 60 | 38 mm

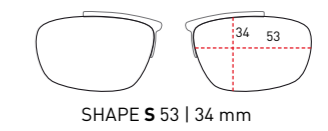

SHAPE S 53 | 34 mm

ACCESSORIES

FLIP UP interface only

- FR 12 88 98** Graphite
- FR 12 88 87** Frozen Ash
- FR 12 88 91** Frozen Crystal







rx readers

Introducing the groundbreaking "Readers" eyewear line from Rudy Project, specifically designed for athletes who see well from a distance but struggle up close when reading bike computers, watches, or newspapers. The all-new RX Readers sunglasses are crafted for sports enthusiasts who require minor vision adjustments without sacrificing style or functionality.



These sport reader prescription lenses are seamlessly integrated into the lower part of the RP Optics sun lens, making it easy for you to read maps or view screens on devices like mobile phones, GPS systems, cycle-computers, and heart rate monitors. The RX Readers offer three configurations of prescription lenses: Smoke, Multilaser Ice, and Multilaser Red. Each of these lenses enhances glare protection while also elevating your aesthetic appearance.

Choose from three different correction powers for each lens color: +1.5, +2.0, and +2.5. With the Rudy Project "Readers" sunglasses, you can confidently and comfortably tackle your favorite sports activities, knowing that you have the perfect combination of style, functionality, and vision support.

RYDON READERS

	CORRECTION POWER +1.50 BLACK MATTE Smoke Black SP 53 B 10 NA 06 - 1500	CORRECTION POWER + 2.00 BLACK MATTE Smoke Black SP 53 B 10 NA 06 - 2000	CORRECTION POWER +2.50 BLACK MATTE Smoke Black SP 53 B 10 NA 06 - 2500
	CORRECTION POWER +1.50 BLACK MATTE Multilaser Ice SP 53 B 68 NA 06 - 1500	CORRECTION POWER + 2.00 BLACK MATTE Multilaser Ice SP 53 B 68 NA 06 - 2000	CORRECTION POWER +2.50 BLACK MATTE Multilaser Ice SP 53 B 68 NA 06 - 2500
	CORRECTION POWER +1.50 BLACK MATTE Multilaser Red SP 53 B 38 NA 06 - 1500	CORRECTION POWER + 2.00 BLACK MATTE Multilaser Red SP 53 B 38 NA 06 - 2000	CORRECTION POWER +2.50 BLACK MATTE Multilaser Red SP 53 B 38 NA 06 - 2500

PROPULSE READERS

	CORRECTION POWER +1.50 BLACK MATTE Smoke Black SP 62 B 10 NA 06 - 1500	CORRECTION POWER + 2.00 BLACK MATTE Smoke Black SP 62 B 10 NA 06 - 2000	CORRECTION POWER +2.50 BLACK MATTE Smoke Black SP 62 B 10 NA 06 - 2500
	CORRECTION POWER +1.50 BLACK MATTE Multilaser Ice SP 62 B 68 NA 06 - 1500	CORRECTION POWER + 2.00 BLACK MATTE Multilaser Ice SP 62 B 68 NA 06 - 2000	CORRECTION POWER +2.50 BLACK MATTE Multilaser Ice SP 62 B 68 NA 06 - 2500
	CORRECTION POWER +1.50 BLACK MATTE Multilaser Red SP 62 B 38 NA 06 - 1500	CORRECTION POWER + 2.00 BLACK MATTE Multilaser Red SP 62 B 38 NA 06 - 2000	CORRECTION POWER +2.50 BLACK MATTE Multilaser Red SP 62 B 38 NA 06 - 2500

WARNING The content of this catalog section is dedicated exclusively to opticians and qualified healthcare operators. Therefore, in compliance with the Italian legislation, I declare under my own responsibility that I am a qualified professional in the optical and/or ophthalmology sector and I am allowed to have access to this content.



rx
flip-up ■

INTRODUCING RUDY PROJECT'S INNOVATIVE "FLIP-UP" EYEWEAR LINE, SPECIFICALLY DESIGNED FOR ATHLETES AND SPORTS ENTHUSIASTS WHO REQUIRE PRESCRIPTION GLASSES. OUR FLIP-UP GLASSES COMBINE THE VERSATILITY OF PERFORMANCE EYEWEAR WITH THE CONVENIENCE OF A UNIQUE FLIP-UP LENS SYSTEM, ALLOWING YOU TO ADAPT SEAMLESSLY TO SUDDEN CHANGES IN LIGHT CONDITIONS.

Equipped with Quick Change Interchangeable Lens Technology, our Flip-up glasses empower players and athletes to effortlessly manage varying light conditions on the field, on the bike, or on the green. This advanced lens system is perfect for sports where quick visual adjustments are crucial, such as baseball, biathlon, golf, shooting, and archery.

Our revolutionary flip-up mechanism allows you to swiftly lift the additional lenses in case of a sudden decrease in light or remove them entirely to maintain only the prescription glasses. This adaptability helps eliminate fogging and ensures optimal visual clarity for a winning performance.

The Rx insert is designed to accommodate a wide variety of prescriptions, offering eyeglass wearers a sleek and stylish alternative to bulky prescription sports eyewear. Experience the perfect fusion of function and fashion with Rudy Project's Flip-up eyewear line, and elevate your game to new heights.



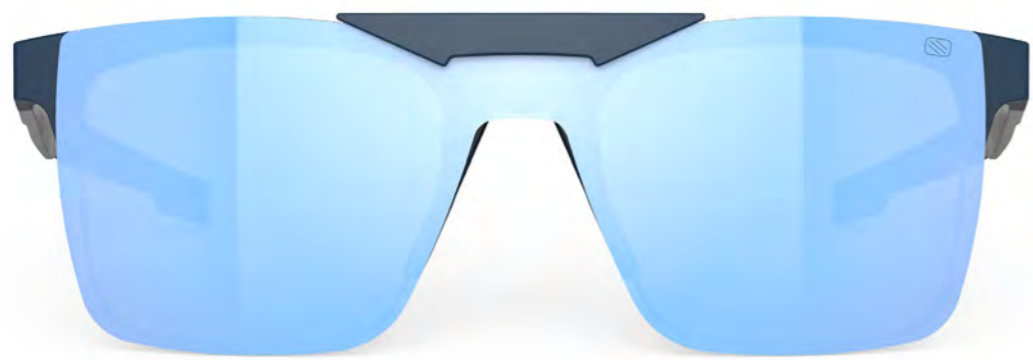

inkas flip up | inkas xl flip up.

o:1,3 g:36

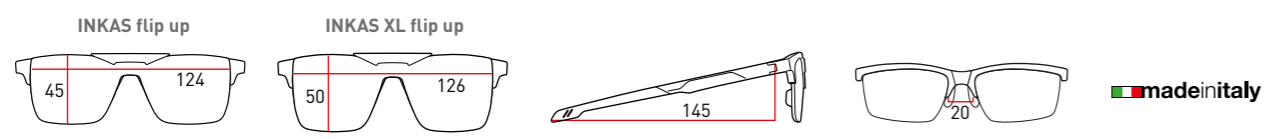

- FLIP-UP**
- INKAS**
FR 68 89 09 Laser Black
 - INKAS XL**
FR 69 89 09 Laser Black
 - INKAS**
FR 68 89 10 Smoke
 - INKAS XL**
FR 69 89 10 Smoke
 - INKAS**
FR 68 89 68 Multilaser Ice
 - INKAS XL**
FR 69 89 68 Multilaser Ice

- ACCESSORIES**
- REPLACEMENT NOSEPADS**
- BLACK
FP 68 77 00
 - BLUE NAVY
FP 68 77 30
- REPLACEMENT TIPS**
- BLACK
FP 68 72 00
 - BLUE NAVY
FP 68 72 30



INKAS
HALF RIM - SHAPE A

FRAMES

HALF RIM - SHAPE A



INKAS
BLACK MATTE
SP 68 09 06 - 0A00



INKAS
BLUE NAVY MATTE
SP 68 68 47 - 0A00



INKAS
DEMI TURTLE GLOSS
SP 68 10 50 - 0A00

INKAS XL
BLACK MATTE
SP 69 09 06 - 0A00

INKAS XL
BLUE NAVY MATTE
SP 69 68 47 - 0A00

INKAS XL
DEMI TURTLE GLOSS
SP 69 10 50 - 0A00

HALF RIM - SHAPE B



INKAS
BLACK MATTE
SP 68 09 06 - 0B00



INKAS
BLUE NAVY MATTE
SP 68 68 47 - 0B00



INKAS
DEMI TURTLE GLOSS
SP 68 10 50 - 0B00

INKAS XL
BLUE NAVY MATTE
SP 69 68 47 - 0B00

FULL RIM



INKAS
BLACK MATTE
SP 68 09 06 - 0000



INKAS
BLUE NAVY MATTE
SP 68 68 47 - 0000



INKAS
DEMI TURTLE GLOSS
SP 68 10 50 - 0000

INKAS XL
DEMI TURTLE GLOSS
SP 69 10 50 - 0000

INKAS CLIPS

FULL RIM



CLIP SIZE 49|40 mm

- BLACK MATTE
FR68 00 00
- BLUE NAVY MATTE
FR68 00 47

SHAPE A



CLIP SIZE 50|41 mm

- LIGHT GUN
FR68 00 02 A

SHAPE B



CLIP SIZE 50|41 mm

- LIGHT GUN
FR68 00 02 B

INKAS XL CLIPS

FULL RIM



CLIP SIZE 51|44 mm

- BLACK MATTE
FR69 00 00
- BLUE NAVY MATTE
FR69 00 47

SHAPE A



CLIP SIZE 52|45 mm

- LIGHT GUN
FR69 00 02 A

SHAPE B



CLIP SIZE 52|45 mm

- LIGHT GUN
FR69 00 02 B



rx
ophthalmic ■

UNLEASH YOUR SPORTY SPIRIT IN EVERYDAY EYEWEAR

INTRODUCING THE OPHTHALMIC LINE, A UNIQUE COLLECTION OF EYEGLASSES DESIGNED FOR THOSE WHO CRAVE A SPORTY LOOK IN THEIR EVERYDAY PRESCRIPTION EYEWEAR. BLENDING ADVANCED SPORTS TECHNOLOGY WITH A LIFESTYLE-ORIENTED DESIGN, OPHTHALMIC GLASSES ARE PERFECT FOR INDIVIDUALS SEEKING TO EXPRESS THEIR ATHLETIC SIDE WHILE ADDRESSING THEIR VISION NEEDS.

Key Features:

- **Sport-Inspired Design:** Drawing from our expertise in high-performance sports eyewear, the Ophthalmic line offers a dynamic, athletic appearance that suits the needs of those requiring prescription lenses for daily use.
- **360-Degree Adjustable Temples:** Experience maximum comfort and stability with our innovative adjustable temple design. Ophthalmic glasses allow for a full 360-degree temple adjustment, ensuring a customized, secure fit for any head shape.
- **Rubber Nose Pads:** To enhance grip and provide a comfortable, secure fit throughout the day, Ophthalmic glasses feature slip-resistant rubber nose pads. These pads prevent the glasses from sliding down the nose, even during intense activities.
- **Versatile Lifestyle Appeal:** While Ophthalmic glasses boast sports-inspired features, they maintain a lifestyle-oriented look that seamlessly transitions from work to play. These stylish frames are perfect for any daily activity, allowing you to embrace your sporty side without compromising on style.

Discover the Ophthalmic line by Rudy Project and experience the perfect fusion of sports functionality and everyday fashion. With Ophthalmic eyewear, you no longer have to choose between performance and style. Embrace your sporty spirit while addressing your vision needs with these exceptional glasses.

Unleash your athletic spirit with Ophthalmic by Rudy Project—where style and performance come together.





NEW lightflow a.

NEW lightflow b.

o:1,2 g:31
BASE 6

o:1,1 g:29
BASE 6

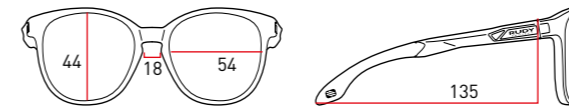
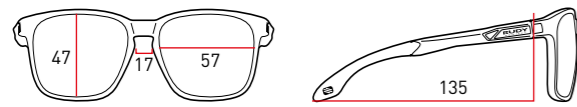

RP OPTICS

RP OPTICS



BLACK MATTE
Demo Lens
SP 82 0A 06 - 0001



CRYSTAL ASH
Demo Lens
SP 82 0A 33 - 0001



BLACK MATTE
Demo Lens
SP 83 0B 06 - 0000



ICE BLUE METAL MATTE
Demo Lens
SP 83 0B 53 - 0000

ACCESSORIES

- FP 56 72 00 Temple tips black
- FP 56 78 00 Z Ergonose black Slim configuration
- FP 56 78 00 ZZ Ergonose black Regular configuration

ACCESSORIES

- FP 56 72 00 Temple tips black
- FP 56 78 00 Z Ergonose black Slim configuration
- FP 56 78 00 ZZ Ergonose black Regular configuration



pulse 53.

o:0,92 g:26 (demo lens)
BASE 6

made in italy



ADJUSTABLE
TEMPLE



RILSAN[®]
CLEAR

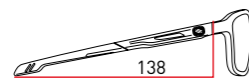

BLACK MATTE
Demo lens
SP 80 0A 06 - 0000



BLACK GLOSS
Demo lens
SP 80 0A 42 - 0000



ICE BLUE METAL MATTE
Demo lens
SP 80 0A 53 - 0000



pulse 54.

o:0,99 g:28 (demo lens)
BASE 6

made in italy



ADJUSTABLE
TEMPLE



RILSAN[®]
CLEAR

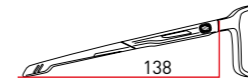

BLACK MATTE
Demo lens
SP 86 0B 06 - 0000



BLACK GLOSS
Demo lens
SP 86 0B 42 - 0000



ICE BLUE METAL MATTE
Demo lens
SP 86 0B 53 - 0000





iridis 65.

o: 0,78 g: 22
(demo lens)

made in italy



ADJUSTABLE
TEMPLE

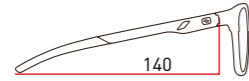
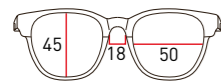

CRYSTAL BROWN DEG
Demo lens
SP 65 0A 29 - 0000



CRYSTAL ASH DEG
Demo lens
SP 65 0A 38 - 0000



CRYSTAL ASH/BLACK GLOSS
Demo lens
SP 65 0A 33 - 0000

REPLACEMENT LENSES AND EMBLEMS

EMBLEMS

BLACK
FP 64 83 06

TIPS

BLACK
FP 64 72 00

BLUE AVIO
FP 64 72 31



iridis 66.

o: 0,81 g: 23
(demo lens)

made in italy



ADJUSTABLE
TEMPLE

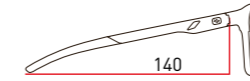
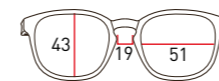

CRYSTAL ASH
Demo lens
SP 66 0A 33 - 0000



BLACK GLOSS
Demo lens
SP 66 0A 42 - 0000



DEMI TURTLE GLOSS
Demo lens
SP 66 0A 50 - 0000

REPLACEMENT LENSES AND EMBLEMS

EMBLEMS

BLACK
FP 64 83 06

TIPS

BLACK
FP 64 72 00

BLUE AVIO
FP 64 72 31

bike helmets ■

ROAD | TRIATHLON | MTB | URBAN

Rudy Project helmets combine performance-driven design with the highest levels of safety to exceed the most stringent impact testing protocols. Our obsession to reduce weight, increase ventilation, optimize aerodynamics, and maximize comfort and fit provide cyclists with the most technologically advanced helmets in the world.

E L E V A T E Y O U R P E R F O R M A N C E





helmets technology ■

1 dual density | eps core

All our helmets use state-of-the-art EPS co-molding technology for enhanced safety, quality and lightweight performance. Loaded with double density EPS core using an innovative internal structure engineered to enhance air circulation and shock absorption capacity, the EGOS is our penultimate development in helmet safety.



2 3d air frame | adaptive band

Our latest generation AirFrame Band has been re-engineered for an even more advanced air flow control; its seamless 3D geometry is designed to distribute ventilation from the front ports through the inner channels helping concretely sweat management; coupled with the adaptive bands connected directly to the retention system, it ensures stability, superior safety and phenomenal 360° comfort fit.

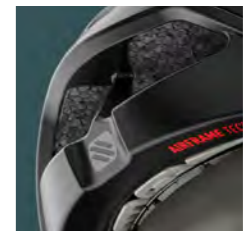

3 rsr micro 11 | retention system

The all-new miniaturized RSR11 retention system is a sturdy yet extremely lightweight and compact safety frame anchored in the helmet: implemented with vertical fitting options and a handy easy-adjust ratchet wheel to provide a swift and exceptional user-friendly adjustment, it will flawlessly secure the helmet around the head.



4 ergo divider | straps

We have developed new ergonomic strap dividers to ensure stability, flush comfort over the skin and simple fitting. No struggling with the adjustments anymore, once tuned to your head it will keep its setting for a superior riding experience.

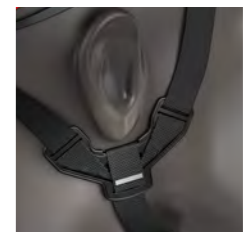

5 fidlock® | chin buckle

The compact magnetic industry-leading FidLock® buckle is intuitive, pinch-free and one handed use even wearing your gloves on. This reliable, comfortable and secure system ensures secure protection in a snap.

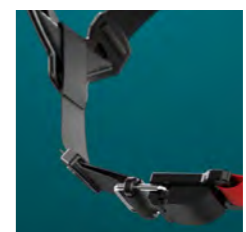

6 eyewear ports

Building on our experience in manufacturing performance eyewear and helmets since 1985, most of our helmets integrate sunglasses dock to securely stow and access them easily.

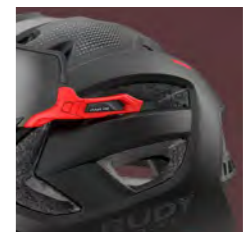

7 helmets-eyewear | powerflow technology

Rudy Project empowers athletes offering sunglasses with vertical PowerFlow channels integrated in the upper part of the eyewear chassis, which once combined with our helmets, will furthermore optimize air circulation.

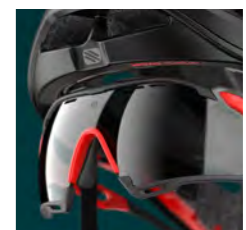



aero helmets technology ■

aerodynamics vs. internal ventilation?

These two elements are most often at odds in the development of an aerodynamic helmet. A very ventilated helmet provokes turbulence which negatively affects aerodynamics, but ventilation benefits physical performance. Because overall performance is what matters most for an athlete, we have conducted extensive testing in the wind tunnel to find the right balance of aerodynamics and ventilation for the development of the Rudy Project helmet collection.

“Triathletes and cyclists often face the most important races of the season in hot and humid weather conditions. These conditions can lead to deterioration, sometimes substantial, of physical performance. Training sessions and races at temperatures above 30-32 degrees Celsius with high relative humidity increase the workload of the cardiovascular, nervous, and metabolic systems due to rising core body temperature.

In addition to weather conditions, physical exertion also contributes to the increase of internal body temperature. This rise is directly correlated with the intensity of the effort. The human body, particularly that of an athlete, is able to modulate these variations by regulating core temperatures through a series of behavioral and physiological interventions. During physical exercise, core temperature increases, especially in hot, humid conditions, and can exceed the normal 36.5-37.5 degree range to as much as 40 degrees centigrade. It should be remembered that at temperatures above 41 degrees centigrade, cellular functions begin to deteriorate. When the internal temperature rises, the body’s natural thermostat (hypothalamus), located in the brain, triggers a series of defense mechanisms (primarily sweating for evaporative cooling) to dissipate heat.

“During physical activity in favorable climatic conditions, the heart provides oxygen through the blood to active muscles, organs, and tissues. When heat and humidity increase, the heart is subjected to an additional workload because it must pump more blood to the skin in order to promote the evaporation of sweat. For this reason, less blood reaches the muscles. The heart rate increases with effort, and therefore the filling time of the heart is reduced with a consequent decrease in cardiac output, leading to a worsening of performance.

“When the internal body temperature begins to increase significantly during physical exercise, even the central nervous system enacts defense mechanisms to contain the production of heat. In particular, it reduces muscle recruitment by deactivating part of the muscles involved in the effort in order to avoid health risks. The inevitable consequence is the reduction of performance capacity.

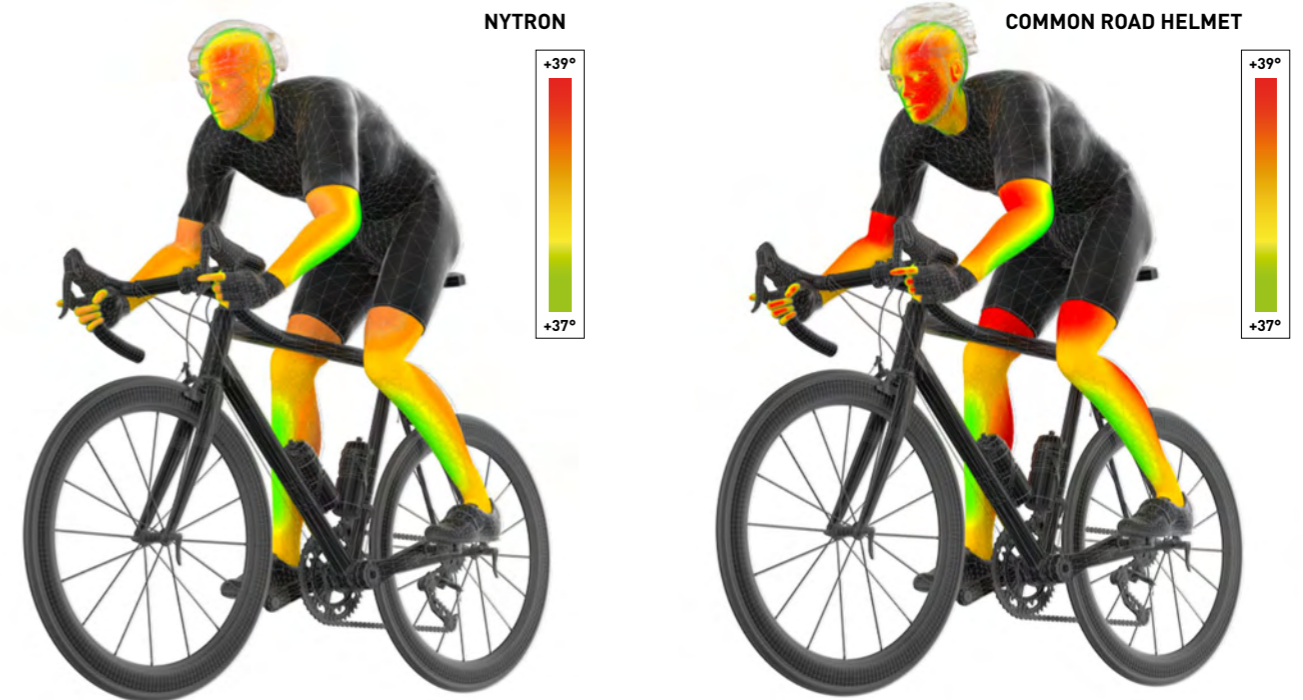

“There is an infinite number of scientific studies showing that during endurance physical activities, body heating and the significant increase in core temperature tend to increase brain response times, decrease response accuracy, and generally affect physical capabilities. It is also widely demonstrated that head cooling is able to counteract these tendencies by mitigating the negative effects of increasing internal body temperature.

“Further scientific contributions have shown that scalp temperature can be considered an important factor in perceived head and overall body comfort, even in scenarios where the internal body temperature remains high. During physical exercise in high heat and humidity, the subjective perception of increased fatigue and workload on the cardiovascular system with consequent decrease in performance is certainly related to the increase in skin temperature, as well as an increase in internal body temperature, which causes critical decreases in cognitive performance.

“A helmet with superior internal ventilation ensures greater heat dissipation, and therefore better thermoregulation and homeostasis of the body’s internal temperature, to the benefit of the athlete’s performance capabilities.”

time trial | 45 km/h wind speed



- simulation setup: 75kg rider, 8.5kg bike, aero drag (baseline) cda 0.250
- * course: 70.3 ironman 90km with 500m climbing, full ironman 180km with 1000m climbing
- power output: 200W average (typical age group athlete on long distance ironman)
- helmets tested in M size



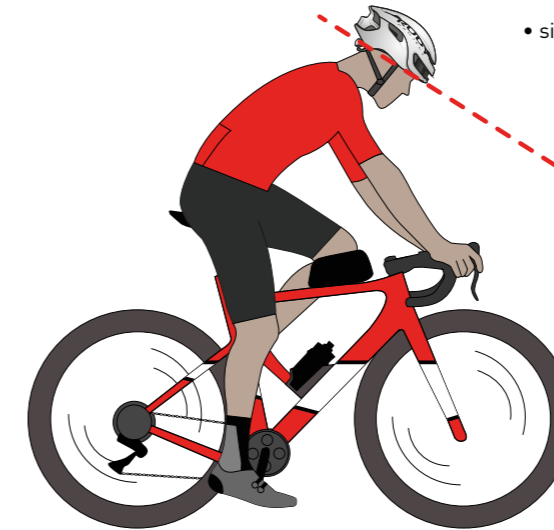

45°





road position | 45 km/h wind speed



- simulation setup: 75kg rider, 8kg bike, aero drag (baseline) cda 0.320
- * course: 100km rolling course with 1500m climbing
- power output: 250W average (typical good amateur cyclist)
- helmets tested in M size

32°

MODEL	AERO DRAG		TIME SAVED *		INTERNAL VENTILATION		
	MERIT AERO ABSOLUTE (W)	MERIT AERO DELTA (W)	IRONMAN 70.3	FULL DISTANCE IRONMAN (S)	COOLING (W)	COOLING DELTA (W)	COOLING CHANGE (%)
THE WING (vents closed) 	237,6	-14,5	134	268	28,6	-17,2	-37,6%
THE WING (vents open) 	241,6	-10,5	96	192	40,1	-5,7	-12,4%
NYTRON 	248,9	-3,2	28	56	44,7	-1,1	-2,4%
SPECTRUM (benchmark) 	252,1	0,0	0	0	45,8	0,0	-0,0%

MODEL	AERO DRAG		TIME SAVED *	INTERNAL VENTILATION		
	MERIT AERO ABSOLUTE (W)	MERIT AERO DELTA (W)	100KM ROLLING COURSE WITH 1500 CLIMBING (S)	COOLING (W)	COOLING DELTA (W)	COOLING CHANGE (%)
THE WING (vents closed) 	283,0	-10,7	82	23,9	-25,9	-52,0%
THE WING (vents open) 	283,2	-10,5	81	42,2	-7,6	-15,3%
NYTRON 	291,8	-1,9	14	46,6	-3,2	-6,4%
SPECTRUM (benchmark) 	293,7	0,0	0	49,8	0,0	-0,0%

FALLS CAN PROVE TO BE VERY COSTLY AND HAVE PERMANENT OR EVEN LETHAL CONSEQUENCES. THE STARTING POINT FOR THE DEVELOPMENT OF RUDY PROJECT'S HELMETS IS THE ADOPTION OF ONLY HIGHLY-ADVANCED MATERIALS WHICH CAN ABSORB SHOCKS AND DISSIPATE THE MECHANICAL ENERGY WITHOUT IT BEING TRANSFERRED TO THE HEAD AND BODY.

Our bicycle helmets, depending on the design and market of destination, comply with the provisions of Module B of the Regulation (EU) 2016/425 "Personal Protective Equipment" and with the national standard transposing the harmonized standard(s) EN 1078:2012+A1:2012 "Helmets for pedal cyclists and for users of skateboards and roller skates" for PPE of Class II, or with American safety standard "CPSC § 12.03 U.S. Consumer Product Safety Commission Safety Standard for Bicycle Helmets for Persons Age 5 and Older."

Check carefully the markers and informations placed on the labels placed on the product and on its packaging to verify the security standards are fulfilled by the helmet. A copy of the declaration of conformity could be downloaded from the website www.rudyproject.com/warranties.

All the Rudy Project helmets are tested in the production sites and by the independent certification authorities.

The purpose of a bike helmet is to protect the rider's head by absorbing the impact energy through the partial, and not always visible, destruction of the helmet itself, including the compression of the interior EPS foam liner.

To be an effective protection for the head/brain, bike helmets have to meet a number of conditions that test how well they perform in an impact, including the strength of the retention system and their stability of the on the wearer's head.

To ensure a uniform standard of safety testing for bicycle helmets, many countries have adopted bike helmet certification standards with which manufacturers and importers must comply.

All the Rudy Project bicycle helmets, depending on the market of destination, comply with one of the following Standards:

CE/EN 1078

Created in 1997, the EN 1078 Standard was approved in 2012 by the European Committee for Standardization (CEN) and amended the same year into the EN 1078:2012+A1:2012 standard for all cycling, skateboarding and roller skating helmets sold in Europe.

The EN 1078 Standard covers helmet construction including field of vision, shock absorbing properties, retention system properties including chin strap and fastening devices, as well as marking and information.

The standard's key features are:

- Test anvils: Flat and kerbstone
- Drop apparatus: Guided free fall
- Ambient, Hot, Cold and wet conditioning
- Impact velocity, energy or drop height flat anvil: 5.42–5.52 m/s
- Impact energy criteria: < 250g
- Roll-off test
- Retention system strength: Force applied dynamically. Helmet supported on headform.

CPSC / CPSC 12.03

In the United States, The Consumer Product Safety Commission (CPSC) was tasked by Congress with the development of a U.S. Government standard for bicycle helmets and began to do so in 1994. After working with an ASTM task group and producing two drafts for public comment, the third and final draft was approved in February of 1998 and the final version of the standard was published. One interpretation letter has been issued since that time. The standard covers all helmets produced for the US market after March 10, 1999.

The CPSC 1203 Standard covers helmet construction including field of vision, shock absorbing properties, retention system properties including chin strap and fastening devices, as well as marking and information.

The standard's key features are:

- Test anvils: Flat, kerbstone and hemispheric
- Drop apparatus: Guided free fall
- Ambient, Hot, Cold and wet conditioning
- Impact velocity, energy or drop height flat anvil: 2 m
- Impact energy criteria: < 300g
- Roll-off test
- Retention system strength: Force applied dynamically. Helmet supported on headform.

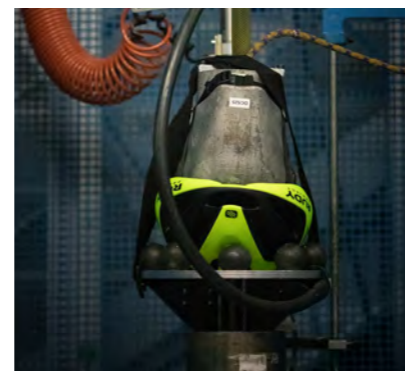
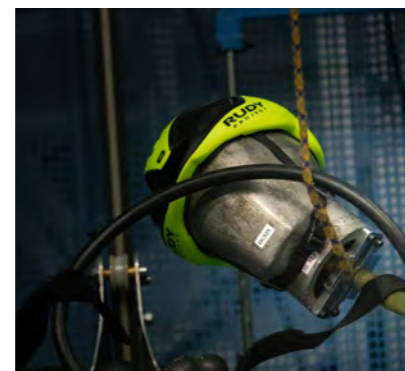

rp rotational impact test

Currently, nearly each research group active within helmet safety has its own definition of helmet safety.

An official Standard that allows measuring and quantifying oblique impact and combines the insight of the different experts would provide a more objective framework of about helmets safety.

On this purpose, CEN (THE EUROPEAN COMMITTEE FOR STANDARDIZATION), through the Technical Committee TC 158 which is dedicated to the head protection and the eight Working Groups currently active under it, is developing a method for measuring the absorption of energy from oblique or normal impacts

The Working Group directly focused on that is known as the CEN TC 158 / Working Group 11.

At Rudy Project we are committed to develop products aiming to the highest level of safety, exceeding the current requirements set by international Standards, such as the CE or CPSC norms.

Today more than ever our goal is to go even further by overpassing also the RP ROTATIONAL IMPACT TEST.

The RP ROTATIONAL IMPACT TEST is an internal protocol adopted by Rudy Project, in cooperation with accredited and notified bodies, to test and measure the performance of the helmets against rotational impacts; it takes inspiration from CEN, from ECE 22.06 (a new standard for motorcycle helmets) and it is based on real accident data and scientific sources.

The RP ROTATIONAL IMPACT TEST "pass-fail" criterion is based on the BRIC (Brain Injury Criterion) value, an algorithm that defines the level of brain injury. This value must be less than 0,68.

*The RP ROTATIONAL IMPACT TEST is a RUDY PROJECT internal protocol to test and measure the performance of the RUDY PROJECT helmets against rotational impacts. This test has not been adopted by CEN or by its Working Group CEN TC 158 / Working Group 11.

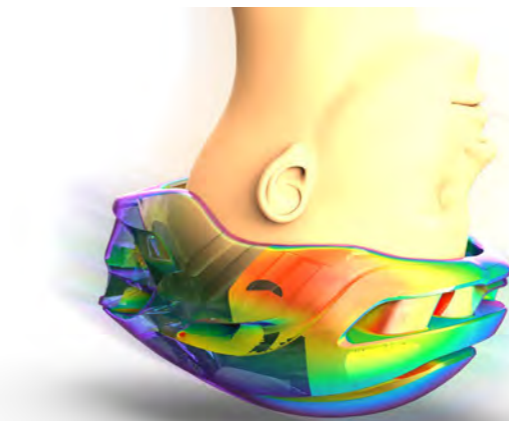

RP ROTATIONAL IMPACT TEST

- oblique tests @ 45° on X,Y and Z axis
- impact speed 6 m/s, BRIC < 0,68
- grade 80 closed-coat aluminum oxide abrasive paper
- headform nominal coefficient of friction 0,3
- wireless system: triaxial accelerometer + n. 3 ARS
- Headform: EN960 serie
- Measurements: Peak of rotational acceleration, Peak of linear acceleration, HIC, BRIC (< 0,68)

EGOS, NYTRON, SPECTRUM, VENGER, VENGER CROSS, PROTERA+ SUCCESSFULLY PASSED RP ROTATIONAL IMPACT TEST

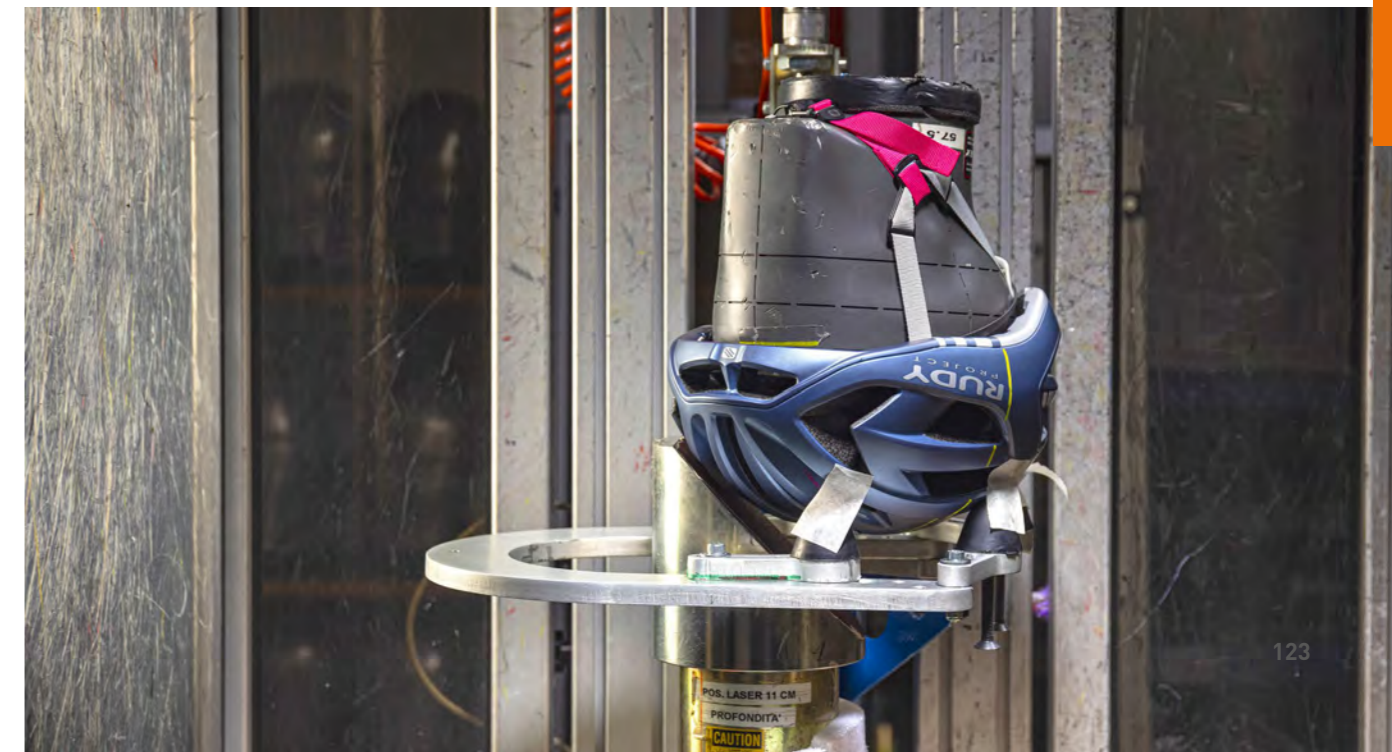



NEW
 COSMIC BLUE (MATTE)
 HL 73 00 61 S - M
 HL 73 00 62 L



BLACK (MATTE)
 HL 73 00 11 S - M
 HL 73 00 12 L



WHITE (SHINY)
 HL 73 00 01 S - M
 HL 73 00 02 L

the wing.



AERO / TRIATHLON	---	---	---	---
ROAD	---	---	---	---
MTB	---	---	---	---
URBAN	---	---	---	---
ALL ROAD	---	---	---	---

S-M cm 55-58 21,7" - 22,8" | L cm 59-61 / 23,2" - 24"
 CE version S-M o:11,3 g:320 - L o:12,7 g:360 | available standards: CE/EN 1078 , CPSC 12.03

- 
2 VENTS
 FLOW THROUGH VENTILATION
- 
TOTAL COMFORT FIT
- 
AIRFRAME BAND ADAPTIVE
- 
DIVIDER PRO SIDE BUCKLES
- 
FASTEX SYSTEM CLOSURE BUCKLE
- 
RSR 10 SM ADJUSTABLE RETENTION SYSTEM
- 
FREE PADS INTERCHANGEABLE COMFORT PADDING

SPARE PARTS

- 

FREE PAD
 Black
 CO 00 04 09

REMOVABLE SHIELD



Laser Black
 LH 73 09
- 

RSR 10 SM RETENTION SYSTEM KIT
 Mirror Chrome
 CO 00 04 39



Transparent
 LH 73 11
- 

Multilaser Orange
 LH 73 40



INCLUDED
 - REMOVABLE SHIELD (laser black)
 - REMOVABLE VENT COVER
 - MICROFIBER POUCH
 - INTERCHANGEABLE FREE PADS

R.S.R. 10 SM Retention System



NEW
 BLUE METAL (SHINY) - BLACK (MATTE)
 HL 77 00 81 S - M
 HL 77 00 82 L



NEW
 PINK FLUO - BLACK (MATTE)
 HL 77 00 91 S - M
 HL 77 00 92 L



BLACK (MATTE)
 HL 77 00 01 S - M
 HL 77 00 02 L



WHITE (MATTE)
 HL 77 00 11 S - M
 HL 77 00 12 L



RED - BLACK (MATTE)
 HL 77 00 21 S - M
 HL 77 00 22 L

nytron.



AERO / TRIATHLON	—	—	—	—	—
ROAD	—	—	—	—	—
MTB	—	—	—	—	—
URBAN	—	—	—	—	—
ALL ROAD	—	—	—	—	—

S-M cm 55-58 / 21,7" - 22,8" | L cm 59-61 / 23,2" - 24"
 CE version S-M o: 8,8 g:250 - L o:10,6 g:300 | available standards: CE/EN 1078 , CPSC 12.03

- 15 VENTS FLOW THROUGH VENTILATION
- DIVIDER PRO SIDE BUCKLES
- FASTEX SYSTEM CLOSURE BUCKLE
- RSR 10 SM ADJUSTABLE RETENTION SYSTEM
- FREE PADS INTERCHANGEABLE COMFORT PADDING



INCLUDED
 - MICROFIBER POUCH
 - INTERCHANGEABLE FREE PADS

NEW nytron pro.

AERO / TRIATHLON	—	—	—	—	—
ROAD	—	—	—	—	—
MTB	—	—	—	—	—
URBAN	—	—	—	—	—
ALL ROAD	—	—	—	—	—

S-M cm 55-58 / 21,7" - 22,8" | L cm 59-61 / 23,2" - 24"
 CE version S-M o: 11,3 g:320 - L o:12,7 g:360 | available standards: CE/EN 1078 , CPSC 12.03

- 3 VENTS FLOW THROUGH VENTILATION
- DIVIDER PRO SIDE BUCKLES
- FASTEX SYSTEM CLOSURE BUCKLE
- RSR 10 SM ADJUSTABLE RETENTION SYSTEM
- FREE PADS INTERCHANGEABLE COMFORT PADDING



WHITE IRIDESCENT (MATTE)
 HL 84 00 01 S - M
 HL 84 00 02 L

SPARE PARTS

FREE PAD
 Black
 CO 00 04 51

RSR 10 M RETENTION SYSTEM KIT
 Mirror Chrome
 CO 00 04 21

features

- WIND TUNNEL-OPTIMIZED FOR THE SPECIFIC HEAD POSITION OF ROAD CYCLISTS
- IMPROVES AERODYNAMICS BY 2 WATTS OVER STANDARD NYTRON
- SLIGHT 11% REDUCTION IN INTERNAL VENTILATION



NEW

RED COMET - BLACK (SHINY)
 HL 78 01 20 S
 HL 78 01 21 M
 HL 78 01 22 L



BLACK (MATTE)
 HL 78 00 00 S
 HL 78 00 01 M
 HL 78 00 02 L



WHITE (MATTE)
 HL 78 00 10 S
 HL 78 00 11 M
 HL 78 00 12 L



COSMIC BLUE (MATTE)
 HL 78 00 20 S
 HL 78 00 21 M
 HL 78 00 22 L

egos.



AERO / TRIATHLON	---	---	---	---
ROAD	---	---	---	---
MTB	---	---	---	---
URBAN	---	---	---	---
ALL ROAD	---	---	---	---

S cm 51-55 / 20,8" - 21,7" | M cm 55-59 / 21,7" - 23,2" | L cm 59-63 / 23,2" - 24,8"
 CE version S o:8,1 g:230 - M o:8,8 g:250 - L o:9,9 g:280 | available standars: CE/EN 1078 , CPSC 12.03

- 23 VENTS
FLOW THROUGH
VENTILATION
- DUAL
DENSITY
- TOTAL
COMFORT
FIT
- AIR
FRAME
BAND
- ERGO DIVIDER
SIDE BUCKLES
- FASTEX SYSTEM
CLOSURE BUCKLE
- RSR 11
ADJUSTABLE
RETENTION
SYSTEM
- FREE PADS
INTERCHANGEABLE
COMFORT PADDING
- BUGSTOP
PADDING



INCLUDED
 - MICROFIBER POUCH
 - FREE PADS INTERCHANGEABLE

SPARE PARTS

BUG STOP
 Interchangeable internal padding with bug stop
 Black
 CO 00 04 75

FREE PADS
 Interchangeable internal padding
 Black
 CO 00 04 76

RSR 10M
 RSR 11 RETENTION SYSTEM KIT
 Black/Grey
 CO 00 04 59



helmet:
EGOS | Red Comet Black
eyewear:
KELION | Crystal Red



RED - BLACK (MATTE)
 HL 65 01 10 S
 HL 65 01 11 M
 HL 65 01 12 L



BLACK (MATTE)
 HL 65 01 30 S
 HL 65 01 31 M
 HL 65 01 32 L



WHITE (MATTE)
 HL 65 01 40 S
 HL 65 01 41 M
 HL 65 01 42 L

spectrum.



AERO / TRIATHLON ———
 ROAD ———
 MTB ———
 URBAN ———
 ALL ROAD ———

S cm 51-55 / 20,1" - 21,7" | M cm 55-59 / 21,7" - 23,2" | L cm 59-63 / 23,2" - 24,8"
 CE version S o:8,1 g:230 - M o:9,2 g:260 - L o:10,6 g:300 | available standard: CE/EN 1078 , CPSC 12.03,AS/NZS2063

- 15 VENTS
FLOW THROUGH VENTILATION
- TOTAL COMFORT FIT
- AIRFRAME BAND ADAPTIVE
- DIVIDER PRO SIDE BUCKLES
- FASTEX SYSTEM CLOSURE BUCKLE
- RSR 10 M ADJUSTABLE RETENTION SYSTEM
- FREE PADS INTERCHANGEABLE COMFORT PADDING
- BUGSTOP PADDING WITH PROTECTIVE NET



INCLUDED
 - FREE PADS INTERCHANGEABLE
 - BUG STOP INTERCHANGEABLE



R.S.R. 10 M. Retention System

SPARE PARTS

- BUG STOP**
Interchangeable internal padding with bug stop
Black
CO 00 04 25
- FREE PADS**
Interchangeable internal padding
Black
CO 00 04 26
- RSR10M**
RSR 10 M RETENTION SYSTEM KIT
Mirror Chrome
CO 00 04 21



BLACK (MATTE)
HL 80 00 91 S - M
HL 80 00 92 L



METAL GREEN/BLACK (MATTE)
HL 80 01 01 S - M
HL 80 01 02 L



SAND (MATTE)
HL 80 01 11 S - M
HL 80 01 12 L



LAGOON (MATTE)
HL 80 01 21 S - M
HL 80 01 22 L

protera+.



AERO / TRIATHLON	—	—	—	—	—
ROAD	—	—	—	—	—
MTB	—	—	—	—	—
URBAN	—	—	—	—	—
ALL ROAD	—	—	—	—	—

S-M cm 55-58 / 21,7" - 22,8" | L cm 59-61 / 23,2" - 24"
CE version S-M o:12,7 g:360 - L o:13 g:370 | available standard: CE/EN 1078 , CPSC 12.03

18 VENTS FLOW THROUGH VENTILATION	AIRFRAME BAND ADAPTIVE	DIVIDER PRO SIDE BUCKLES	QUICK SNAP STRAPS	FASTEX SYSTEM CLOSURE BUCKLE	STRAP RETAINER	RSR 9 ADJUSTABLE RETENTION SYSTEM	FREE PADS INTERCHANGEABLE COMFORT PADDING	BUGSTOP PADDING WITH PROTECTIVE NET



INCLUDED
- VISOR ADJUSTABLE
- FREE PADS
INTERCHANGEABLE

- BUG STOP INTERCHANGEABLE
- STRAP RETAINER

RSR 9 Retention System

SPARE PARTS

	BUG STOP Interchangeable internal padding with bug stop Black C0 00 03 91		VISOR (screws included)		STRAP RETAINER (screws included)
	FREE PADS Interchangeable internal padding Black C0 00 03 92		Black AC 40 00 64		Black C0 00 04 34
	RSR9 RETENTION SYSTEM KIT Black / Grey C0 00 04 06		Sand Matte AC 40 00 75		Sand Matte C0 00 04 73
	SPARE STRAPS Interchangeable straps kit.		Lagoon Matte AC 40 00 76		Lagoon Matte C0 00 04 74
	Black C0 00 03 97				



METAL GREEN (SHINY) /BLACK MATTE
 HL 66 00 60 S
 HL 66 00 61 M
 HL 66 00 62 L



WHITE (MATTE)
 HL 66 00 70 S
 HL 66 00 71 M
 HL 66 00 72 L



BLACK (MATTE)
 HL 66 00 40 S
 HL 66 00 41 M
 HL 66 00 42 L



LIGHT GREY - BLACK (MATTE)
 HL 66 00 50 S
 HL 66 00 51 M
 HL 66 00 52 L

venger cross.



AERO / TRIATHLON
 ROAD
 MTB
 URBAN
 ALL ROAD

S cm 51-55 / 20,1" - 21,7" | M cm 55-59 / 21,7" - 23,2" | L cm 59-63 / 23,2" - 24,8"
 CE version S o:8,5 g:240 - M o:9,2 g:260 - L o:9,9 g:280 [available standard: CE/EN 1078 , CPSC 12.03

- 22 VENTS FLOW THROUGH VENTILATION
- TOTAL COMFORT FIT
- ADAPTIVE AIRFRAME BAND
- DIVIDER PRO SIDE BUCKLES
- FASTEX SYSTEM CLOSURE BUCKLE
- RSR 10 ADJUSTABLE RETENTION SYSTEM
- FREE PADS INTERCHANGEABLE COMFORT PADDING
- BUGSTOP PADDING WITH PROTECTIVE NET

SPARE PARTS

- BUG STOP Interchangeable internal padding with bug stop
CO 00 04 10 Black
- FREE PAD Interchangeable internal padding
CO 00 04 11 Black
- RSR 10 RETENTION SYSTEM KIT
Black / Grey
CO 00 04 20

VISOR

- White
AC 40 00 68
- Black
AC 40 00 72



INCLUDED
 - 1 VISOR
 - FREE PADS INTERCHANGEABLE
 - BUG STOP INTERCHANGEABLE



RSR 10 Retention System



venger.



AERO / TRIATHLON
ROAD
MTB
URBAN
ALL ROAD

S cm 51-55 / 20,1" - 21,7" | M cm 55-59 / 21,7" - 23,2" | L cm 59-63 / 23,2" - 24,8"
CE version S o:7,8 g:220 - M o:8,5 g:240 - L o:9,2 g:260 | available standard: CE/EN 1078 , CPSC 12.03

- 22 VENTS FLOW THROUGH VENTILATION
- TOTAL COMFORT FIT
- ADAPTIVE AIRFRAME BAND
- DIVIDER PRO SIDE BUCKLES
- FASTEX SYSTEM CLOSURE BUCKLE
- RSR 10 ADJUSTABLE RETENTION SYSTEM
- FREE PADS INTERCHANGEABLE COMFORT PADDING
- BUGSTOP PADDING WITH PROTECTIVE NET



INCLUDED
- FREE PADS INTERCHANGEABLE
- BUG STOP INTERCHANGEABLE



RSR 10 Retention System



WHITE - SILVER (MATTE)
HL 66 01 00 S
HL 66 01 01 M
HL 66 01 02 L



TITANIUM - BLACK (MATTE)
HL 66 01 10 S
HL 66 01 11 M
HL 66 01 12 L



RED - BLACK (MATTE)
HL 66 01 50 S
HL 66 01 51 M
HL 66 01 52 L



IRIDESCENT BLUE (SHINY)
HL 66 01 70 S
HL 66 01 71 M
HL 66 01 72 L



AZUR - BLACK (MATTE)
HL 66 01 60 S
HL 66 01 61 M
HL 66 01 62 L

REFLECTIVE



GUN MATTE - (SHINY)
HL 66 11 00 S
HL 66 11 01 M
HL 66 11 02 L



YELLOW MATTE - (SHINY)
HL 66 11 10 S
HL 66 11 11 M
HL 66 11 12 L



SPARE PARTS



BUG STOP
Interchangeable internal padding with bug stop
C0 00 04 10 Black



FREE PAD
Interchangeable internal padding
C0 00 04 11 Black



RSR 10 RETENTION SYSTEM KIT
Black / Grey
C0 00 04 20

BIKE HELMETS



LIGHT GREY (MATTE)
HL 76 00 61 S-M
HL 76 00 62 L



LAGOON (MATTE)
HL 76 00 71 S-M
HL 76 00 72 L



WHITE - (MATTE)
HL 76 00 01 S-M
HL 76 00 02 L



LEAD / BLACK (MATTE)
HL 76 00 11 S-M
HL 76 00 12 L









BLACK/RED (SHINY)
HL 76 00 41 S-M
HL 76 00 42 L

crossway.

AERO / TRIATHLON	—	—	—	—	—
ROAD	—	—	—	—	—
MTB	—	—	—	—	—
URBAN	—	—	—	—	—
ALL ROAD	—	—	—	—	—

S-M cm 55-58 / 21,7" - 22,8" | L cm 59-61 / 23,2" - 24"
CE version S-M o:8,8 g:250 - L o:9,5 g:270 | available standard: CE/EN 1078 , CPSC 12.03

- 
23 VENTS
FLOW THROUGH VENTILATION
- 
TOTAL COMFORT FIT
- 
ADAPTIVE AIRFRAME BAND
- 
FASTEX SYSTEM CLOSURE BUCKLE
- 
RSR10S
RSR 10 S ADJUSTABLE RETENTION SYSTEM
- 
BUGSTOP PADDING WITH PROTECTIVE NET



INCLUDED
- BUG STOP INTERCHANGEABLE



RSR 10S Retention System

SPARE PARTS

 **BUG STOP**
Interchangeable internal padding with bug stop
Black
C0 00 04 44





 **RSR 10 S RETENTION SYSTEM KIT**
Black / Grey
C0 00 04 43



skudo.

AERO / TRIATHLON	—	—	—	—	—
ROAD	—	—	—	—	—
MTB	—	—	—	—	—
URBAN	—	—	—	—	—
ALL ROAD	—	—	—	—	—

S-M cm 55-58 / 21,7" - 22,8" | L cm 59-61 / 23,2" - 24"
 CE version S-M o:8,8 g:250 - L o:9,5 g:270 | available standards: CE/EN 1078 , CPSC 12.03

- 
23 VENTS
 FLOW THROUGH VENTILATION
- 
ERGO DIVIDER
 SIDE BUCKLES
- 
FASTEX
 SYSTEM CLOSURE BUCKLE
- 
RSR11S
 RSR 11 S ADJUSTABLE RETENTION SYSTEM
- 
BUGSTOP
 PADDING WITH PROTECTIVE NET



INCLUDED
 - FREE PADS INTERCHANGEABLE



RSR DISC Retention System



NEW
 PINK FLUO - BLACK (MATTE)
 HL 79 00 51 S - M
 HL 79 00 52 L



BLACK (MATTE)
 HL 79 00 01 S - M
 HL 79 00 02 L



WHITE (SHINY)
 HL 79 00 11 S - M
 HL 79 00 12 L



SAND (SHINY)
 HL 79 00 21 S - M
 HL 79 00 22 L





MANGO (SHINY)
 HL 79 00 31 S - M
 HL 79 00 32 L



TEAL (SHINY)
 HL 79 00 41 S - M
 HL 79 00 42 L

SPARE PARTS

 **BUG STOP**
 Interchangeable internal padding with bug stop
 Black
 CO 00 04 77

 **RSR11S**
 RSR 11 S - RETENTION SYSTEM
 CO 00 04 60



BLACK (MATTE)
 HL 81 00 01 S - M
 HL 81 00 02 L

central+.

AERO / TRIATHLON	_____
ROAD	_____
MTB	_____
URBAN	_____
ALL ROAD	_____

S-M cm 54-58 / 21,3" - 22,8" | L cm 59-61 / 23,2" - 24"
 CE version S-M o:9,5 g: 270 - L o:10,9 g:310 | available standards: CE/EN 1078 , CPSC 12.03

9 VENTS FLOW THROUGH VENTILATION	ADAPTIVE AIRFRAME BAND	DIVIDER PRO SIDE BUCKLES	QUICK SNAP STRAPS	FASTEX SYSTEM CLOSURE BUCKLE	RSR 10 V ADJUSTABLE RETENTION SYSTEM	BUGSTOP PADDING WITH PROTECTIVE NET



INCLUDED
 - 1 VISOR REMOVABLE
 - BUG STOP INTERCHANGEABLE
 - ACCESSORY PADS



INCLUDED
 Light and removable visor.
 It is attached with a quick snap system.
 RSR 10 V Retention System

SPARE PARTS

BUG STOP
 Interchangeable internal padding with bug stop
 Grey
 CO 00 03 81

VISOR
 Black
 AC 40 00 47

RSR 10 V RETENTION SYSTEM KIT
 Black / Grey
 CO 00 04 30

SPARE STRAPS
 Interchangeable straps kit.

Black
 CO 00 04 00

Red
 CO 00 04 01

Sky
 CO 00 04 02

Silver
 CO 00 04 03

Pink
 CO 00 04 05



BLACK (SHINY)
HL 82 00 01 S - M
HL 82 00 02 L



WHITE (SHINY)
HL 82 00 11 S - M
HL 82 00 12 L



RED (SHINY)
HL 82 00 21 S - M
HL 82 00 22 L



LAGOON (SHINY)
HL 82 00 31 S - M
HL 82 00 32 L

strym z.



AERO / TRIATHLON	—	—	—	—
ROAD	—	—	—	—
MTB	—	—	—	—
URBAN	—	—	—	—
ALL ROAD	—	—	—	—

S-M cm 55-58 / 21,7" - 22,8" | L cm 59-61 / 23,2" - 24"
CE version S-M o:8,8 g:250 - L o:9,5 g:270 | available standards: CE/EN 1078, CPSC 12.03, AS/NZS 2063

16 VENTS FLOW THROUGH VENTILATION	TOTAL COMFORT FIT	ADAPTIVE AIRFRAME BAND	DIVIDER PRO SIDE BUCKLES	FASTEX SYSTEM CLOSURE BUCKLE	RSR10 ADJUSTABLE RETENTION SYSTEM



INCLUDED
- FREE PADS INTERCHANGEABLE



RSR 10 Retention System

SPARE PARTS

FREE PADS
Interchangeable internal padding
Silver
C0 00 04 78

RSR10 RETENTION SYSTEM KIT
C0 00 04 20 Black / Grey

helmet protector.

Fits any Rudy Project helmet

BLACK
AC 08 00 58
Integrated Eyewear Dock
Light and sturdy, fits any helmets.



helmet sizing | fitting

CM	48.2	51.1	52	53	53.9	54.9	55.8	56.8	57.7	58.7	59.6	60.6	61.5	62.5
INCHES	19	20 ¹ / ₈	20 ¹ / ₂	20 ⁷ / ₈	21 ¹ / ₄	21 ⁵ / ₈	22	22 ³ / ₈	22 ³ / ₄	23 ¹ / ₈	23 ¹ / ₂	23 ⁷ / ₈	24 ¹ / ₄	24 ⁵ / ₈
CAP SIZE	6	6 ³ / ₈	6 ¹ / ₂	6 ⁵ / ₈	6 ³ / ₄	6 ⁷ / ₈	7	7 ¹ / ₈	7 ¹ / ₄	7 ³ / ₈	7 ¹ / ₂	7 ⁵ / ₈	7 ³ / ₄	7 ⁷ / ₈

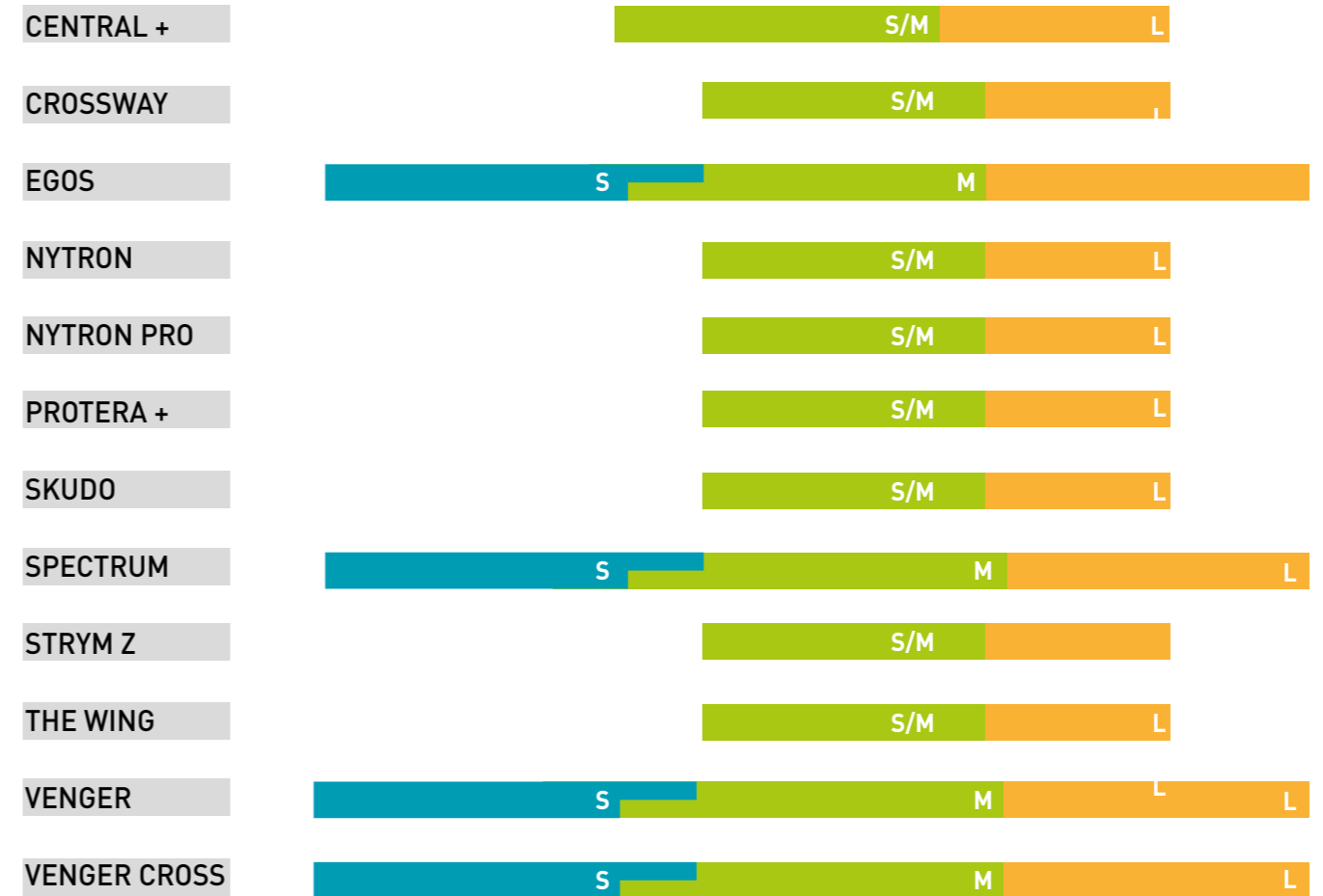

helmet sizing guide.

- 01** LOCATE MEASURING INSTRUMENT
Locate a pliable measuring ribbon or a mobile charging cable (and a straightedge to compare it against).
- 02** TAKE MEASUREMENT
Encircle the cable around your head slightly over the brow line.
- 03** DETERMINE YOUR SIZE
Consult the table above to identify your fitting.
If you're between two dimensions, opt for the smaller one.

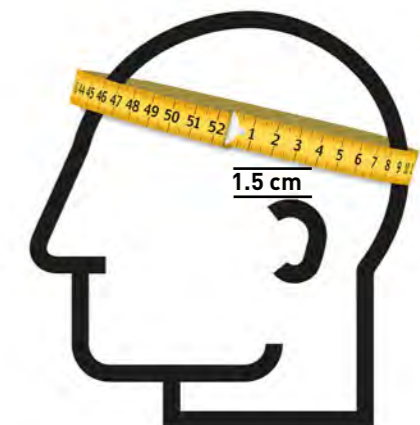



Egos helmet / Cutline eyewear



color match.

There is an intense relationship between the Rudy Project collections and their colour combinations; shapes, volumes, materials and perception in all of its senses have deeply inspired the creative team. Rudy Project's constant research into colour is evident in its winning choices and combinations, the reward for a decade's worth of experience and an unrivalled spirit of innovation. Here's a small selection of color matching products. Have fun creating other matching combinations while discovering our full collection!



SNOW



Protecting the eyes in the harshest weather conditions and guaranteeing a high level of comfort are the main objectives that led Rudy Project to create its snow collection. The attractive and practical design, and the optical solutions developed for this collection, certify the attention that is paid to every type of sport and every athlete.

E L E V A T E Y O U R P E R F O R M A N C E



SNOW



spincut.

o:4,3 g:123

CUSTOM FOAM PADDING INCORPORATED DIRECTLY INTO THE GOGGLE FRAME

RX-READY WITH OUR GOGGLE INSERT

WIDE CYLINDRICAL DOUBLE LENS CONSTRUCTION TO OPTIMIZE FITTING

INNOVATIVE QUICK-CHANGE INTERCHANGEABLE SYSTEM EASY-IN /EASY-OUT



made in italy

OTG
OVER THE GLASS

IMPACTX®



BLACK MATTE
ImpactX® Photochromic 2 laser Purple DL
MK 21 75 66 - 0000



LIGHT GREY MATTE
ImpactX® Photochromic 2 laser Purple DL
MK 21 75 04 - 0000

RP OPTICS



BLACK GLOSS
Multilaser Gold DL
MK 21 57 03 - 0000



WHITE GLOSS
Multilaser Ice DL
MK 21 45 69 - 0000



BONDI BLUE
Multilaser Orang DL
MK 21 40 02 - 0000



WHITE GLOSS
Kayvon Red DL
MK 21 21 69 - 0000

ACCESSORIES



GOGGLE OPTICAL INSERT
The all new RX Goggle Optical Insert is an excellent value solution for prescription wearers. The clip can be effortlessly inserted or removed and is fully compatible with our Skermo and Klonyx Snow goggles.
☞>87
FR 12 00 00

REPLACEMENT LENSES

IMPACTX®
LK 21 75 ImpactX® Photochromic 2 Laser Purple

RP OPTICS
LK 21 45 Multilaser Ice (cat.3)
LK 21 57 Multilaser Gold (cat.3)
LK 21 40 Multilaser Orange (cat.3)
LK 21 21 Laser Kayvon Red (cat.2)



skermo.

o:6,6 g:187

TWIN-BUCKLE REMOVABLE STRAP WITH INNER SILICONE STRIPES

ADVANCED PERIPHERAL VISION

RPOPTICS MULTILASER ANTIFOG DOUBLE LENS

TRIPLE-LAYER FACE FOAM SUPERIOR SOFT COMFORT

HELMET COMPATIBLE SLEEK CYLINDRICAL DESIGN

LOW PROFILE PU FRAME GEOMETRY



INTERCHANGEABLE LENSES

RP OPTICS



BLACK MATTE
Multilaser Orange
MK 20 40 06 - 0001



DEEP BLUE MATTE
Multilaser Blue
MK 20 43 59 - 0000

ACCESSORIES



GOGGLE OPTICAL INSERT
The all new RX Goggle Optical Insert is an excellent value solution for prescription wearers. The clip can be effortlessly inserted or removed and is fully compatible with our Skermo and Klonyx Snow goggles.
☞>87
FR 12 00 00

style finder.

EYEWEAR



AGENT Q
pg.32



ASTRAL
pg.56



CROZE
pg.77



CUTLINE
pg.36



DEFENDER
pg.38



DELTABEAT
pg.60



GUARD
collection
pg.64



KELION
pg.34



IMPACT RX
collection
pg.88



INKAS
pg.96



INKAS FLIP-UP
pg.104



INKAS XL
pg.96



INKAS XL FLIP-UP
pg.104



IRIDIS 65
pg.112



IRIDIS 66
pg.113



LIGHTFLOW A
pg.68



LIGHTFLOW B
pg.69



LIGHTFLOW A | RX
pg.108



LIGHTFLOW B | RX
pg.109



MAGNUS
pg.44



MAYA
pg.98



OVERLAP
pg.71



PROPULSE
pg.62



PULSE 53
pg.110



PULSE 54
pg.111



RYDON
pg.50



RYDON SLIM
pg.52



RX DIRECT
collection
pg.88



RX DIRECT CLIP
collection
pg.94



RX OPTICAL DOCK
collection
pg.92



RX OPTICAL INSERT
collection
pg.90



RX READERS
collection
pg.100



SKYTRAIL
pg.76



SIRIUS
pg.58



SKERMO
pg.155



SOUNDRISE
pg.75



SPINAIR 57
pg.73



SPINHAWK
pg.74



SPINCUT
pg.154



SPINSHIELD
pg.54



SPINSHIELD AIR
pg.55



STARDASH
pg.48



STELLAR
pg.70



TRALYX +
pg.40



TRALYX+ SLIM
pg.42

HELMETS



CENTRAL +
pg.144



CROSSWAY
pg.140



EGOS
pg.128



NYTRON
pg.126



NYTRON PRO
pg.127



PROTERA +
pg.134



SKUDO
pg.142



SPECTRUM
pg.132



STRYM Z
pg.146



THE WING
pg.124



VENGER
pg.138



VENGER CROSS
pg.136

RUDY PROJECT S.p.A Via B. Marcello, 44 - 31100 Treviso, Italy
Phone +39 0422 433 011 - Fax +39 0422 431 978 - info@rudypoint.com - www.rudypoint.com

FIND YOUR NEAREST RUDY PROJECT DISTRIBUTORS FOLLOWING THIS LINK:
WWW.RUDYPROJECT.COM/WW/EN/DISTRIBUTORS.HTML

Rudy Project pursues a policy of technological research and constant development of its products, so that the specifications and products illustrated in this catalogue are subject to change without notice. Rudy Project is not responsible for typographical mistakes or errors in printing colors. The best way to verify the color is to see the product at your Rudy Project retailer. All athletes and/or teams (names and/or pictures) shown in this catalogue are referred only and exclusively to the year 2020/2021.



MIX
Paper from
responsible sources
FSC® C112256

helmets collection.

	THE WING		NYTRON		EGOS			SPECTRUM			PROTERA +	
	AERO/TRIATHLON		AERO/TRIATHLON ROAD		AERO/TRIATHLON ROAD			AERO/TRIATHLON ROAD MTB ALL ROAD			MTB ALL ROAD	
SIZES	S-M 55-58 cm 21,7-22,8"	L 59-61 cm 23,2-24"	S-M 55-58 cm 21,7-22,8"	L 59-61 cm 23,2-24"	S 51-55 cm 20,1-21,7"	M 55-59 cm 21,7-23,2"	L 59-63 cm 23,2-24,8"	S 51-55 cm 20,1-21,7"	M 55-59 cm 21,7-23,2"	L 59-63 cm 23,2-24,8"	S-M 55-58 cm 21,7-22,8"	L 59-61 cm 23,2-24"
WEIGHT	320 g 11,3 oz	340 g 12,7 oz	250 g 8,8 oz	300 g 10,6 oz	230 g 8,1 oz	250 g 8,8 oz	280 g 9,9 oz	230 g 8,1 oz	240 g 9,2 oz	300 g 10,6 oz	340 g 12,7 oz	370 g 13 oz
IN MOLD TECHNOLOGY	■				■			■			■	
WIND TUNNEL TESTED	■		■					■				
FLOW THROUGH VENTILATION	2		15		25			15			18	
RETENTION SYSTEM	RSR 10 S M		RSR 10 M		RSR 11			RSR 10 M			RSR 9	
VERTICAL ADJUSTABILITY	■		■		■			■			■	
CLOSURE CHIN BUCKLE	FASTEX buckle		FASTEX buckle		FIDLOCK buckle			FASTEX buckle			FASTEX buckle	
DIVIDER SIDE BUCKLE	DIVIDER PRO		DIVIDER PRO		ERGO DIVIDER			DIVIDER PRO			DIVIDER PRO	
BUG STOP PADDING					■			■			■	
SNAP VISOR											■	
SAFETY REFLEX			■		■			■			■	
MICROFIBER POUCH	■		■		■			■				
AVAILABLE STANDARDS	CE/EN 1078 CPSC 12.03		CE/EN 1078 CPSC 12.03		CE/EN 1078 CPSC 12.03			CE/EN 1078 CPSC 12.03			CE/EN 1078 CPSC 12.03	

	VENGER CROSS			VENGER			CROSSWAY		CENTRAL +		SKUDO		STRYM Z	
	MTB ALL ROAD			ROAD ALL ROAD MTB URBAN			MTB ALL ROAD		URBAN		ROAD MTB ALL ROAD URBAN		ROAD MTB ALL ROAD URBAN	
SIZES	S 51-55 cm 20,1-21,7"	M 55-59 cm 21,7-23,2"	L 59-63 cm 23,2-24,8"	S 51-55 cm 20,1-21,7"	M 55-59 cm 21,7-23,2"	L 59-63 cm 23,2-24,8"	S-M 55-58 cm 21,7-22,8"	L 59-61 cm 23,2-24"	S-M 54-58 cm 21,3-22,8"	L 59-61 cm 23,2-24"	S-M 55-58 cm 21,7-22,8"	L 59-61 cm 23,2-24"	S-M 55-58 cm 21,7-22,8"	L 59-61 cm 23,2-24"
WEIGHT	240 g 8,5 oz	260 g 9,2 oz	280 g 9,9 oz	220 g 7,8 oz	240 g 8,5 oz	260 g 9,2 oz	250 g 8,8 oz	270 g 9,5 oz	270 g 9,5 oz	310 g 10,9 oz	250 g 8,8 oz	280 g 9,9 oz	250 g 8,8 oz	270 g 9,5 oz
IN MOLD TECHNOLOGY	■						■		■		■			■
WIND TUNNEL TESTED														
FLOW THROUGH VENTILATION	22			22			23		9		17			16
RETENTION SYSTEM	RSR 10			RSR 10			RSR 10 S		RSR 10 V		RSR 11 S			RSR 10
VERTICAL ADJUSTABILITY	■			■			■		■		■			■
CLOSURE CHIN BUCKLE	FASTEX buckle			FASTEX buckle			FASTEX buckle		FASTEX buckle		FASTEX buckle			FASTEX buckle
DIVIDER SIDE BUCKLE	DIVIDER PRO			DIVIDER PRO			DIVIDER PRO		DIVIDER PRO		ERGO DIVIDER			DIVIDER PRO
BUG STOP PADDING	■			■			■		■		■			■
SNAP VISOR	■			■			■		■		■			■
SAFETY REFLEX	■			■			■		■		■			■
MICROFIBER POUCH														
AVAILABLE STANDARDS	CE/EN 1078 CPSC 12.03			CE/EN 1078 CPSC 12.03			CE/EN 1078 CPSC 12.03		CE/EN 1078 CPSC 12.03		CE/EN 1078 CPSC 12.03			CE/EN 1078 CPSC 12.03

ATTENTION

The Rudy Project helmets are engineered and manufactured with different specifications according to the markets of destination. If your helmet bears a CE designation, it meets the requirements of the Council Directive 89/686/ECC and of the European technical Standard EN 1078. If your helmet bears a CPSC designation, it meets the standard safety requirements of the U.S. Consumer Product Safety Commission. If your helmet bears a AS/NZS designation, it meets the standard safety requirements of the Australian Standard AS/NZS 2063.